

Part Reference	Description
PP-FREC-SY-DI-SU	C3-C6 Symphony Diatonic - 22 notes (Surface Fix)

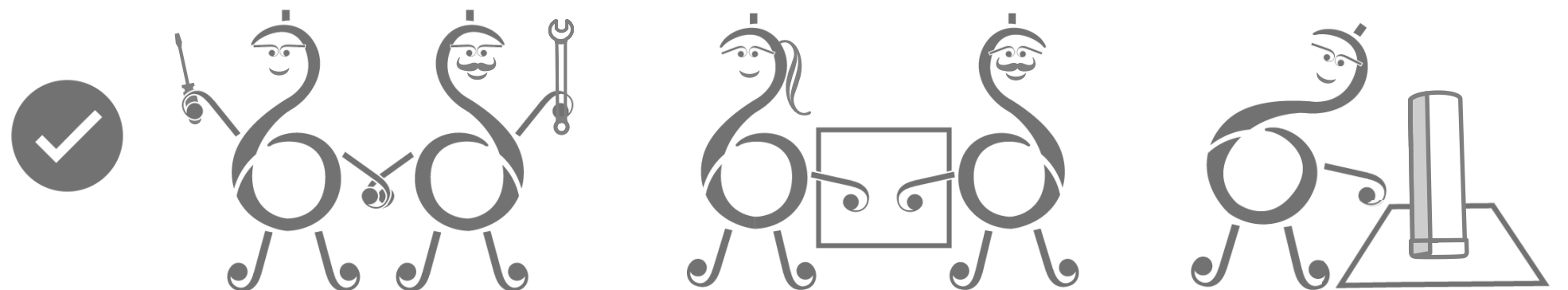

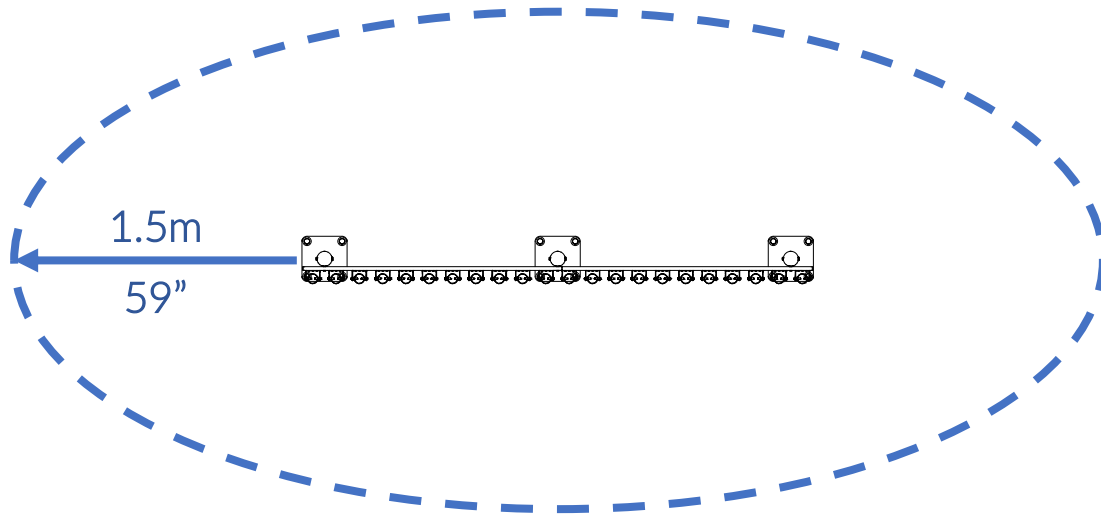



Check Risk Assessment

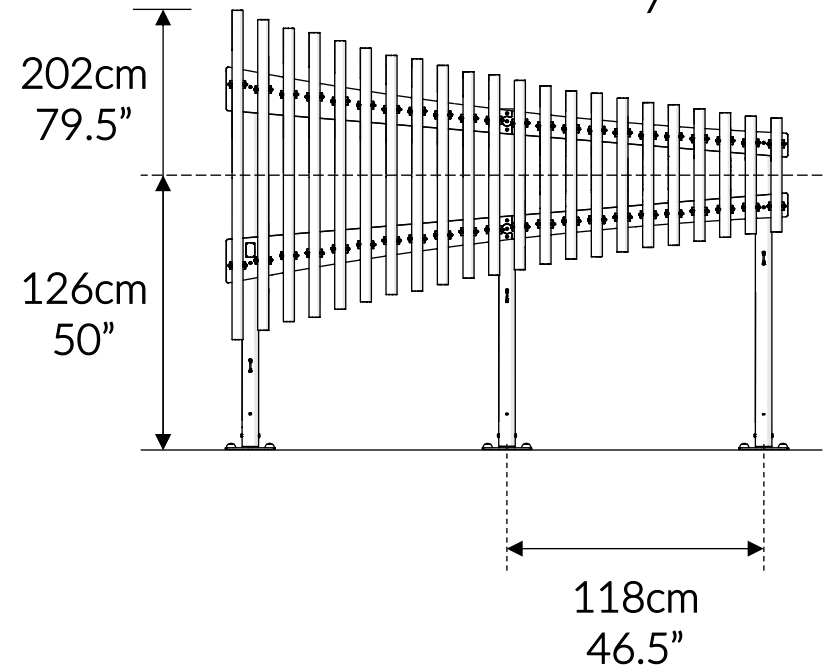
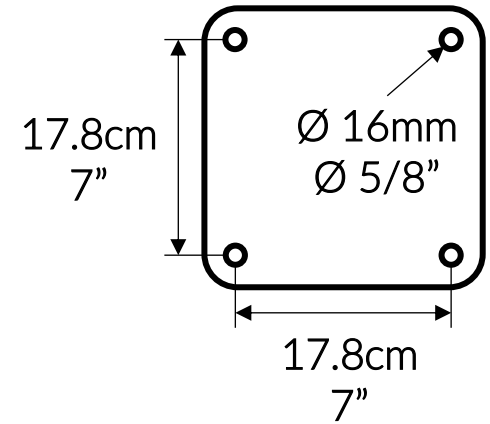

Packages

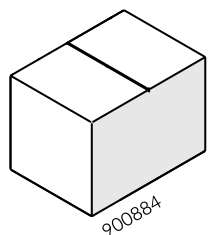

x3

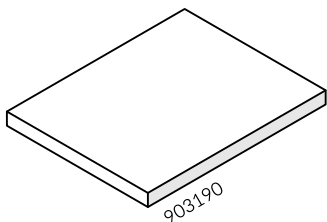

x1

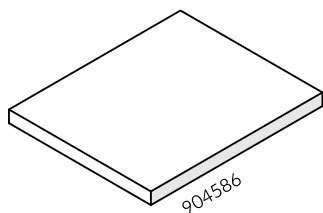

x1

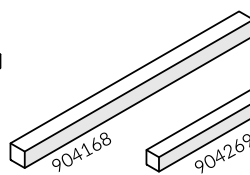

x1

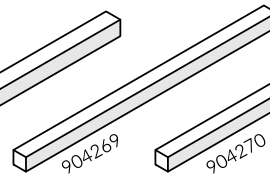

x1

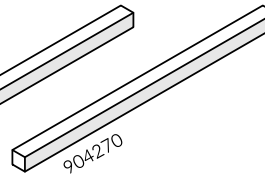

x1

		L	W	H	Weight	Net
x3	900884	23cm / 9"	23cm / 9"	31cm / 12"	6kg / 13lbs	
x1	903190	155cm / 61"	137cm / 54"	15cm / 6"	21kg / 46lbs	
x1	904586	120cm / 47"	137cm / 54"	15cm / 6"	21kg / 46lbs	
x1	904168	160cm / 63"	10cm / 4"	10cm / 4"	8kg / 17.5lbs	
x1	904269	200cm / 79"	10cm / 4"	10cm / 4"	8kg / 17.5lbs	
x1	904270	200cm / 79"	10cm / 4"	10cm / 4"	8kg / 17.5lbs	

Tools required (not supplied)

¼" Bit Driver Ratchet

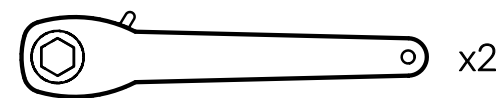

x2

¼" hex adapter

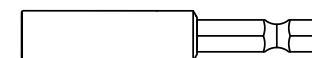

Spirit level

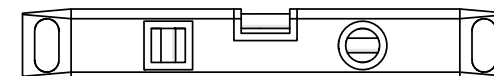

Tape Measure

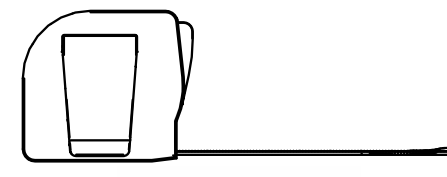

903190

① x1

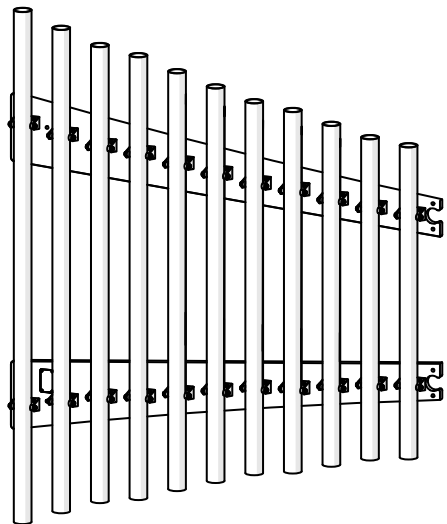

TX30 x1
500473



TX40 x1
500474

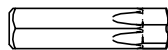

Ⓐ x6
502452



⑦ x1
900837

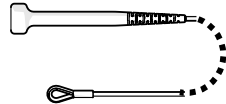

Ⓑ x6
500456

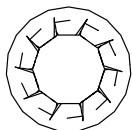

⑧ x2
900832

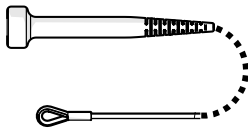

904586

② x1

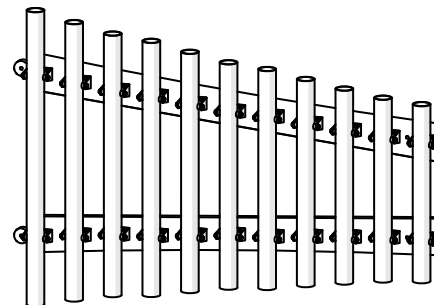

TX30 x1
500473



TX40 x1
500474

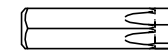

Ⓐ x4
502452



⑦ x1
900837

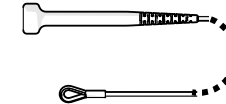



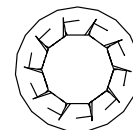

Ⓑ x4
500456

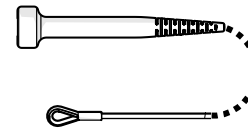

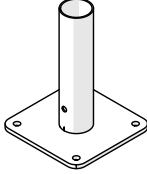
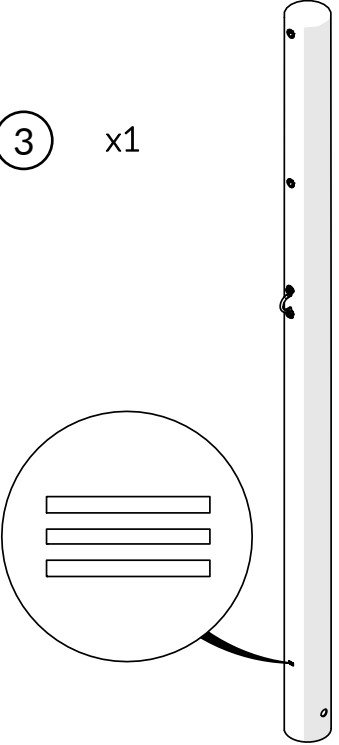
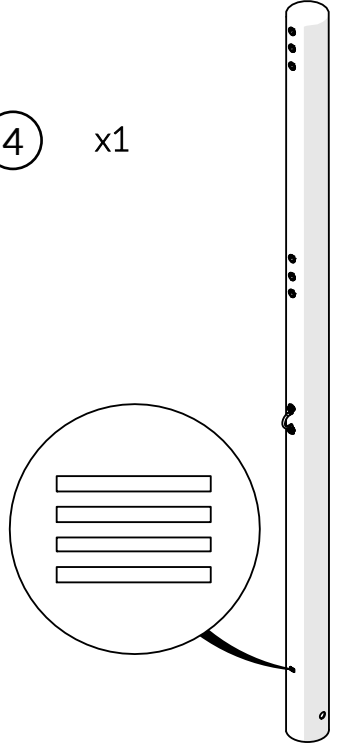
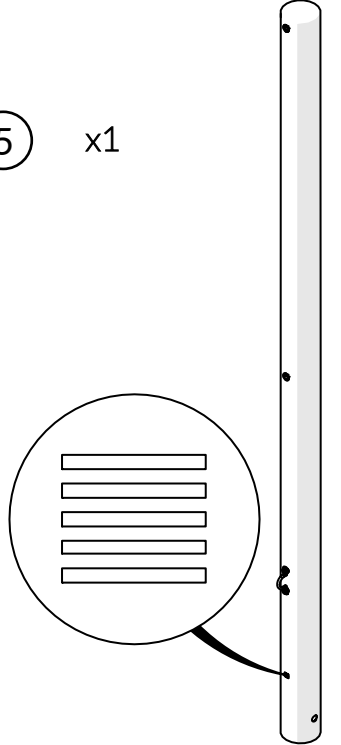
⑧ x2
900832

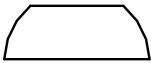

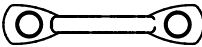
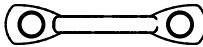
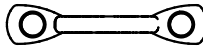
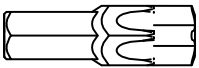
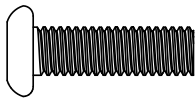
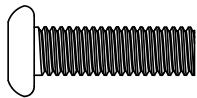
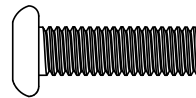
900884	x3	904168	904269	904270
<p>⑥ x1 800878</p> 		<p>③ x1</p> 	<p>④ x1</p> 	<p>⑤ x1</p> 
<p>⑤ x1 500667</p> 				
<p>⑦ x1 500613</p> 				
<p>⑧ x4 601543</p> 				
<p>⑨ x4 601542</p> 		<p>① x1 603150</p> 	<p>① x1 603150</p> 	<p>① x1 603150</p> 
<p>TX45 x2 500720</p> 		<p>② x2 500746</p> 	<p>② x2 500746</p> 	<p>② x2 500746</p> 

1.

1.1

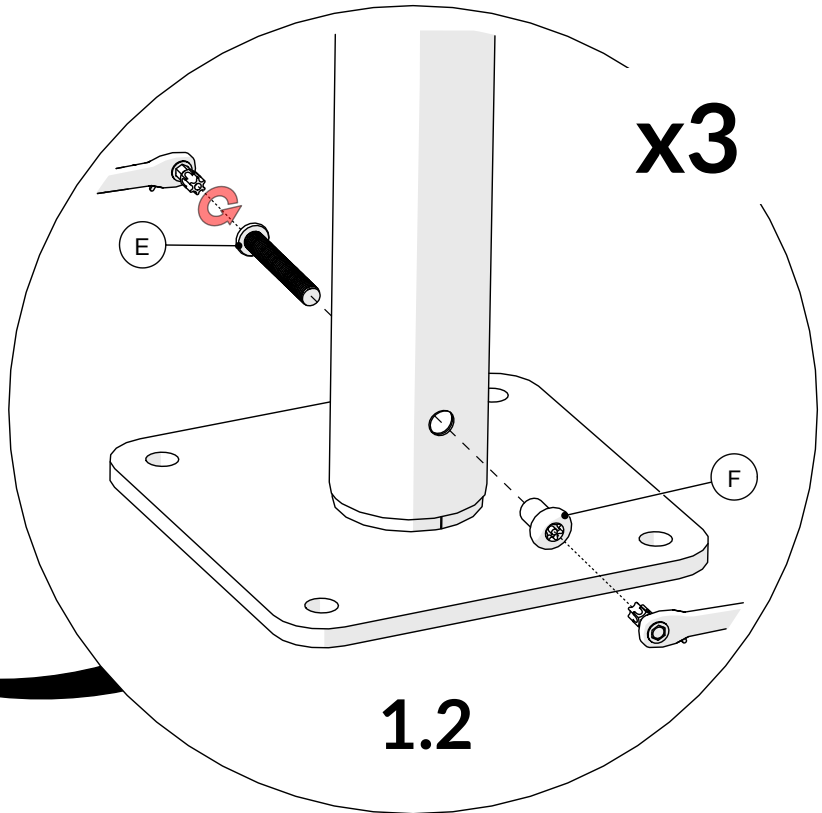
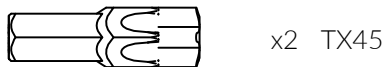
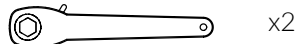
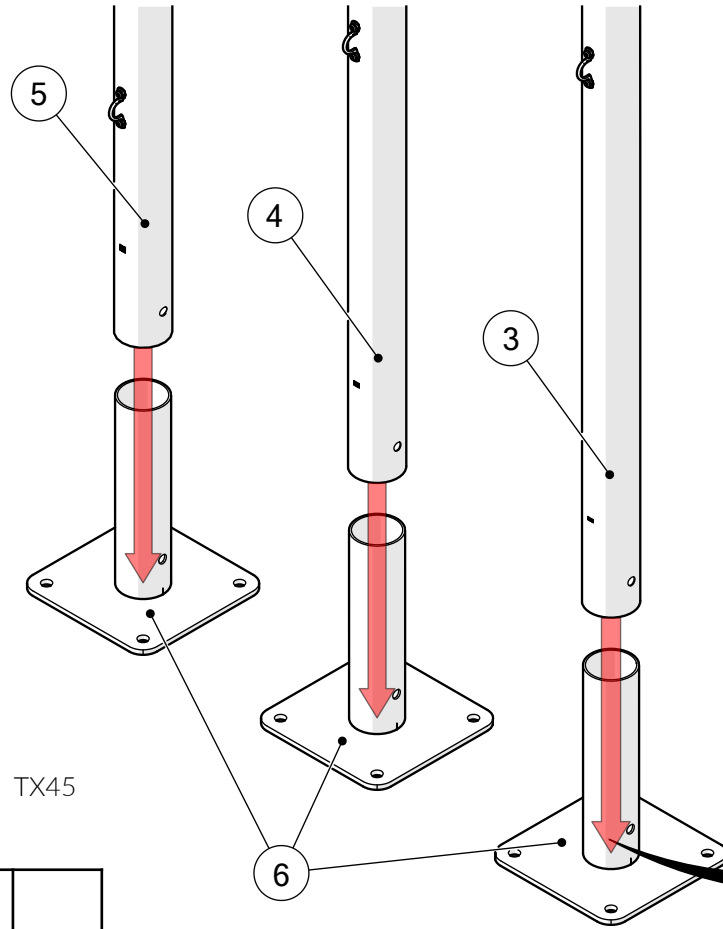

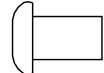
E		x3
F		x3

2.

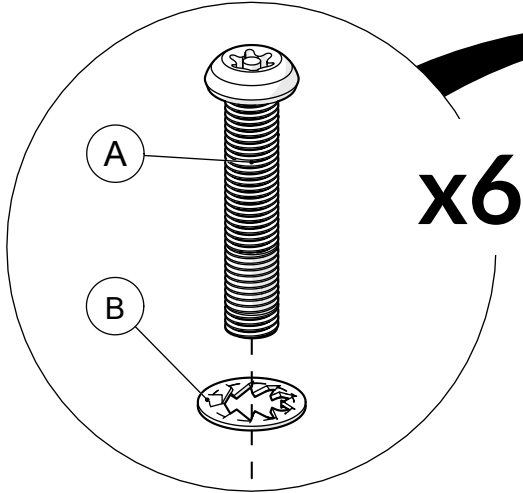
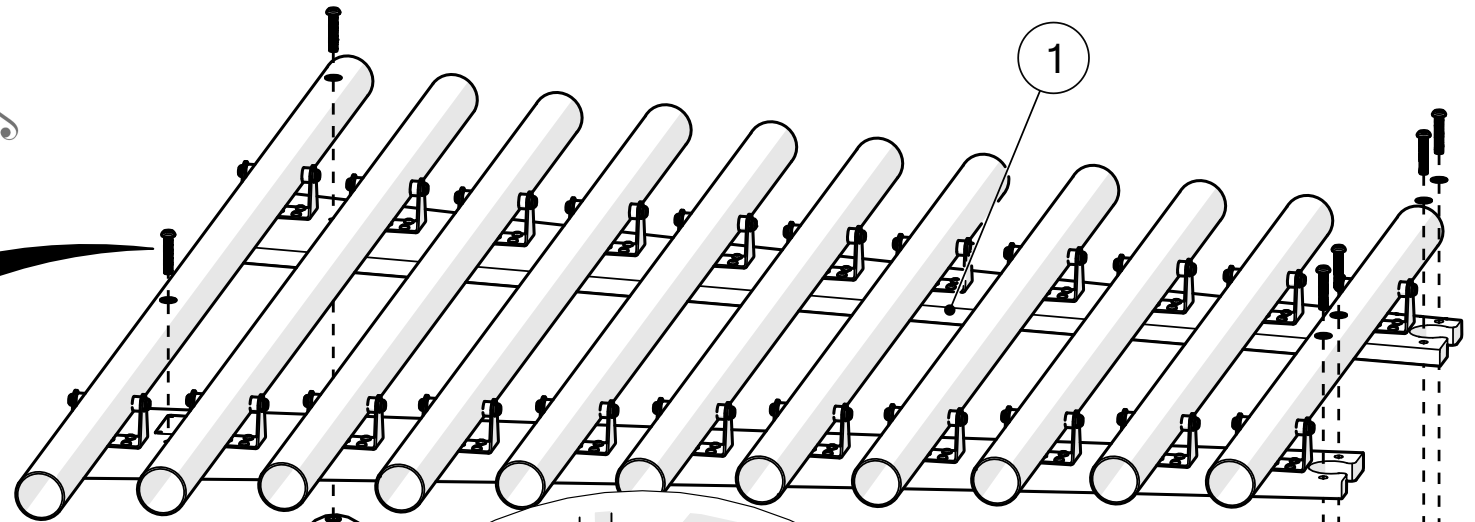
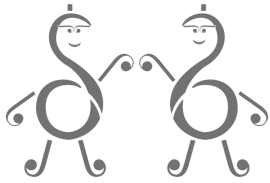

A		x6
B		x6

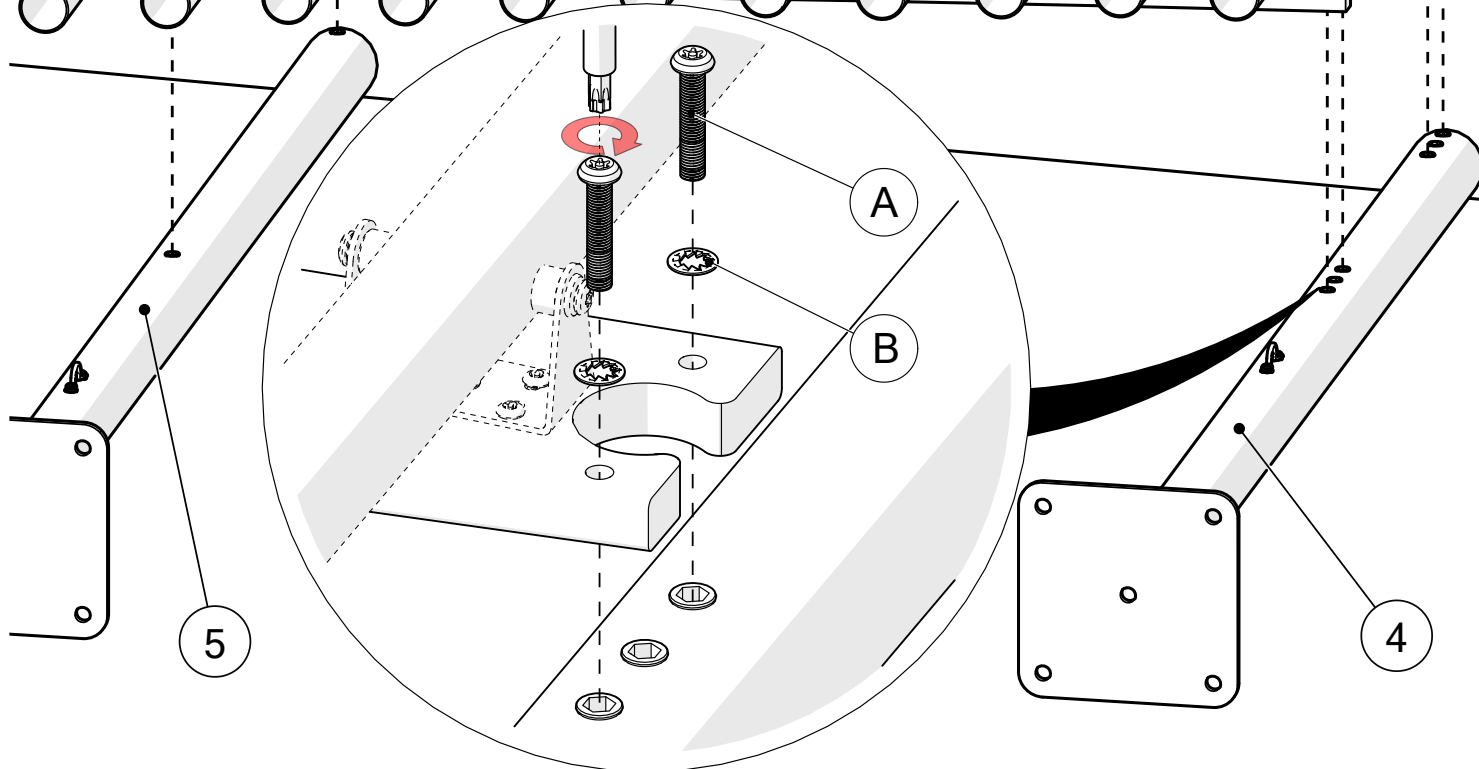

3.

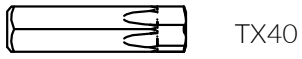
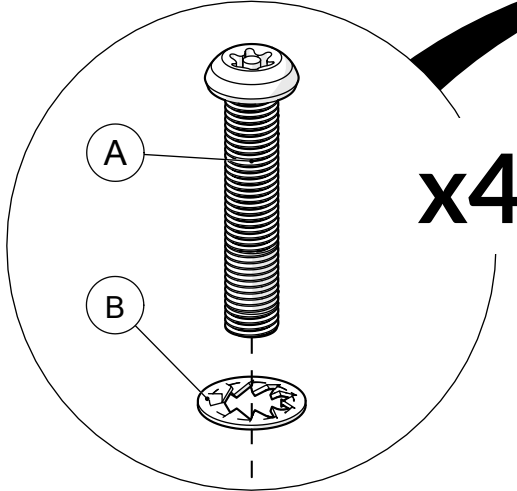
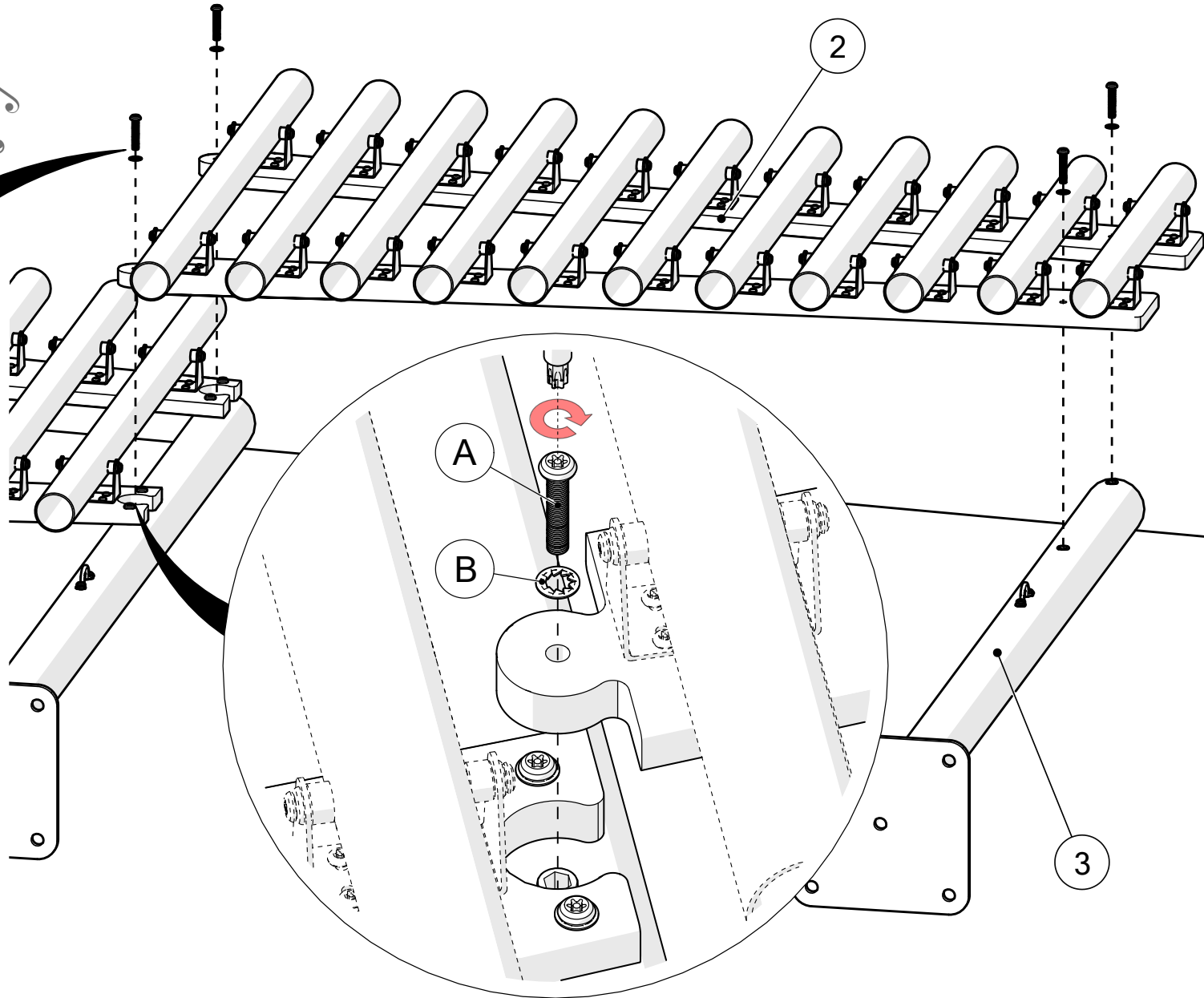
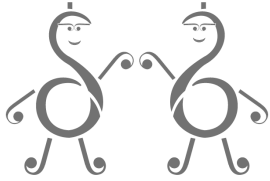

A		x4
B		x4

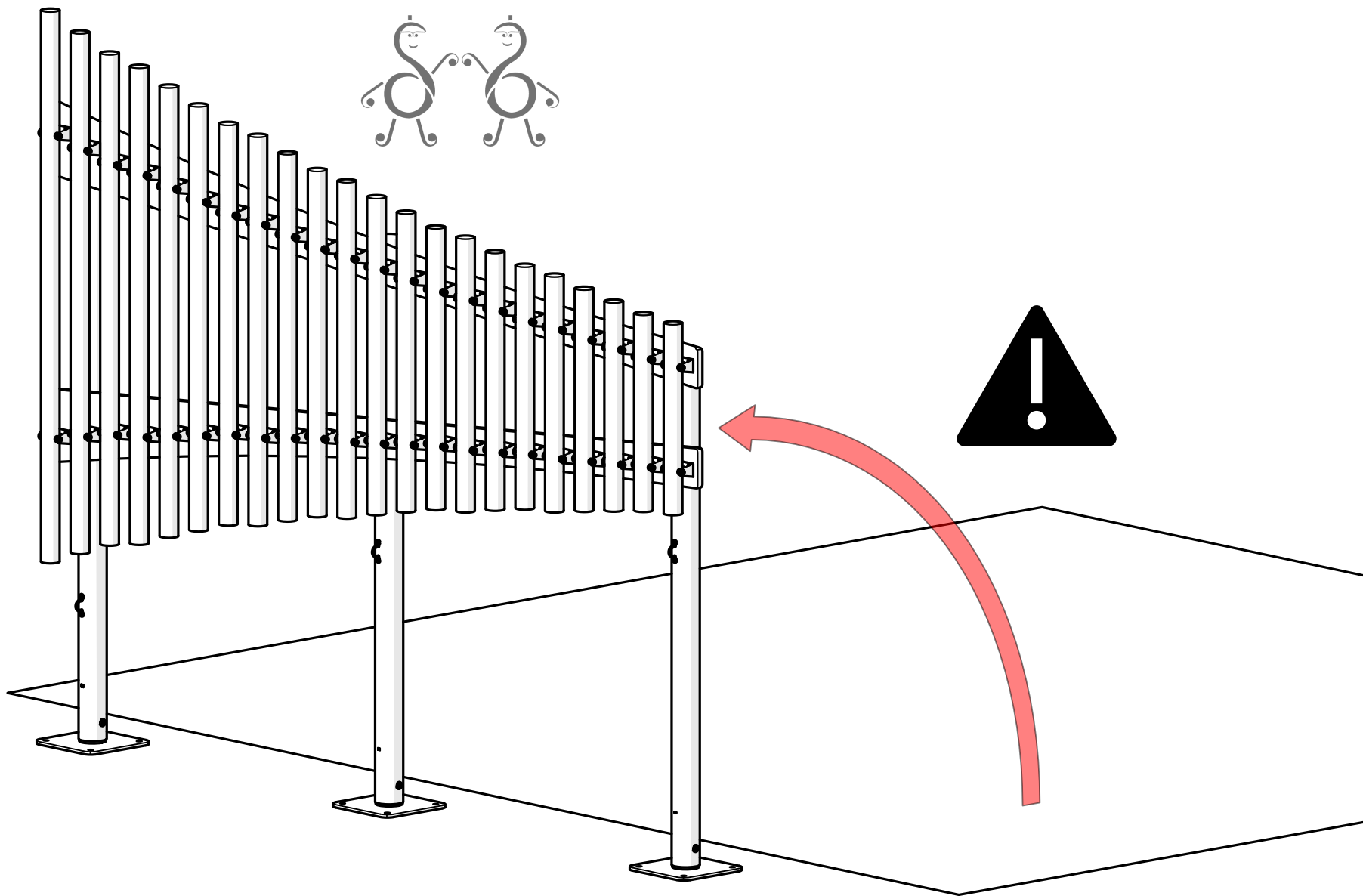

4. x3

Surface fixing should not present a hazard



Refer to your local Health & Safety standards

G		x12
H		x12

Surface

Example fixing

	Wood		x12
	Concrete		x12
	Brick		x12

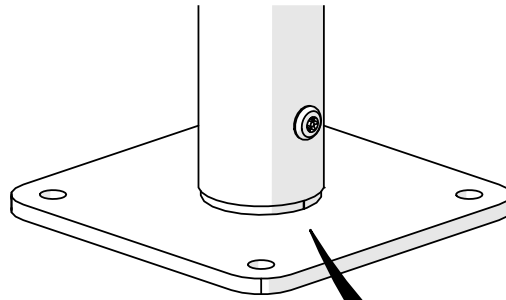

x12

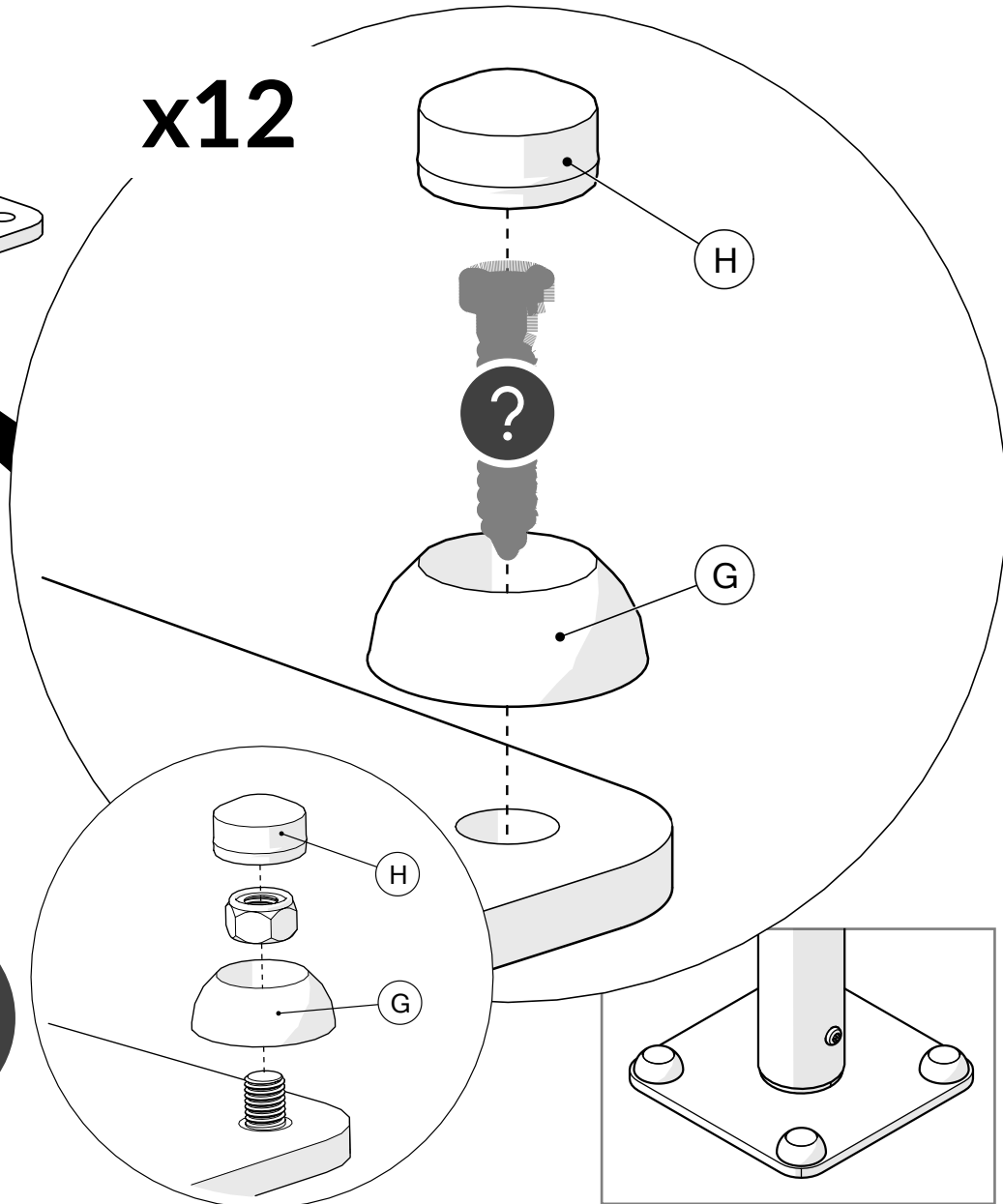

5.



TX30

7		x2
8		x4
C		x3
D		x6

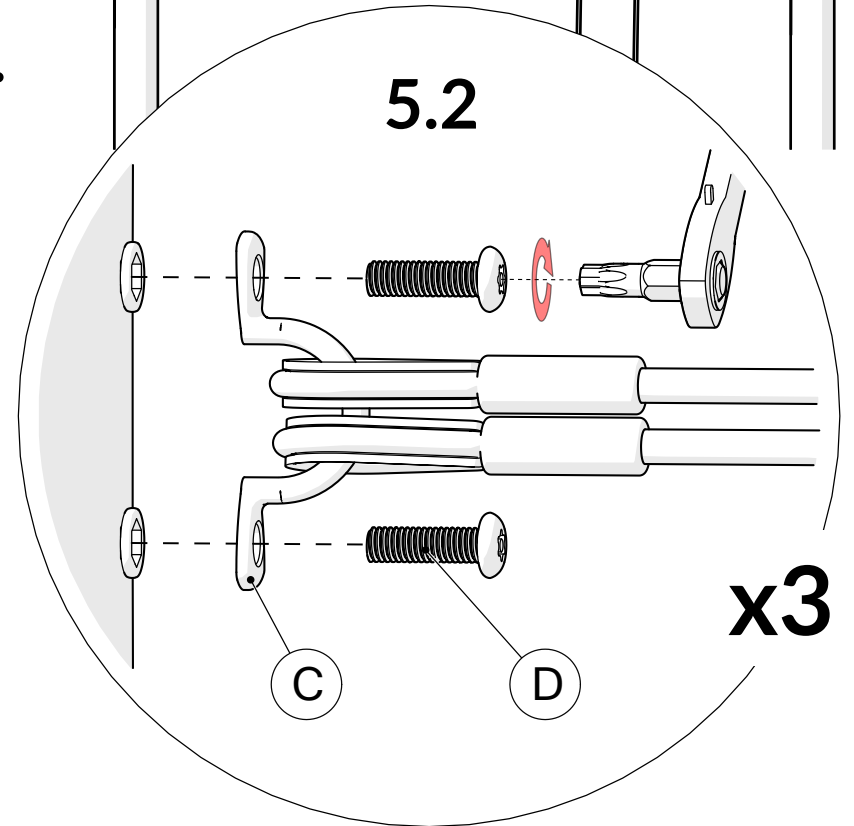
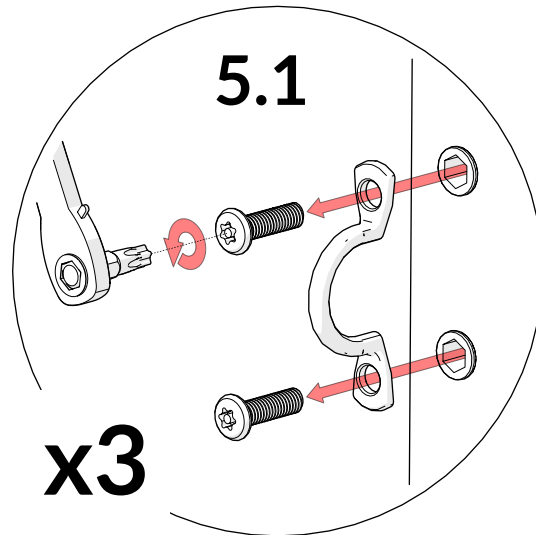
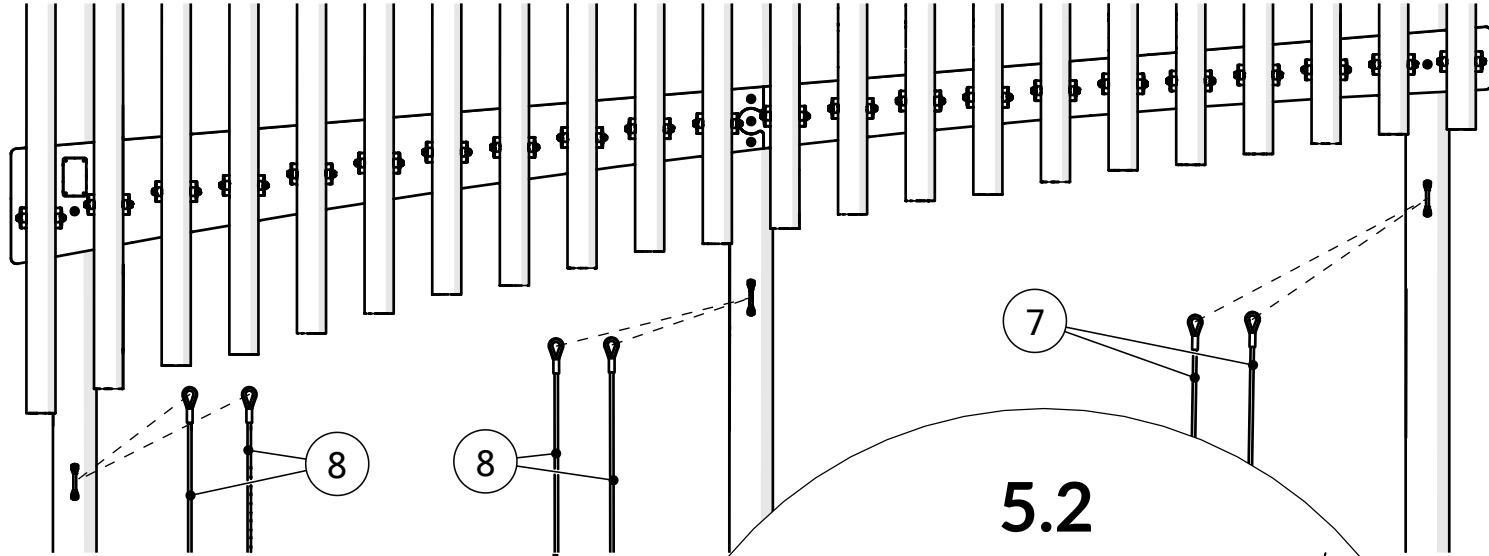

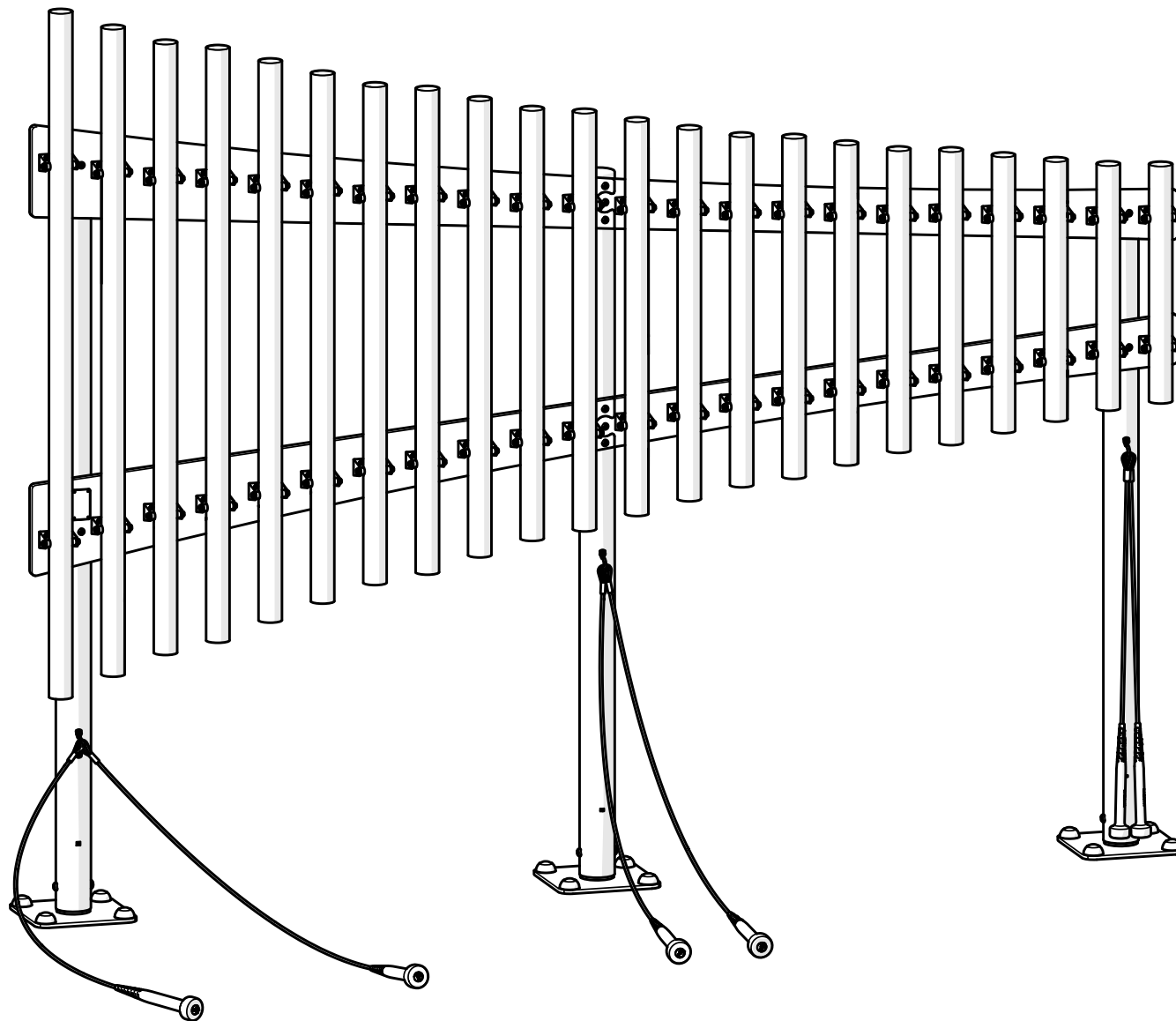

percussionplay.com



info@percussionplay.com



UK
[01730 235 180](tel:+441730235180)

USA & CAN
[+1 \(866\) 882 9170](tel:+18668829170)

EUR & ROW
[+44 1730 235 180](tel:+441730235180)