

Part Reference	Description
PP-EMPE-ST-03-SU	Emperor Chimes (Set of 3) - Silver (Surface Fix)

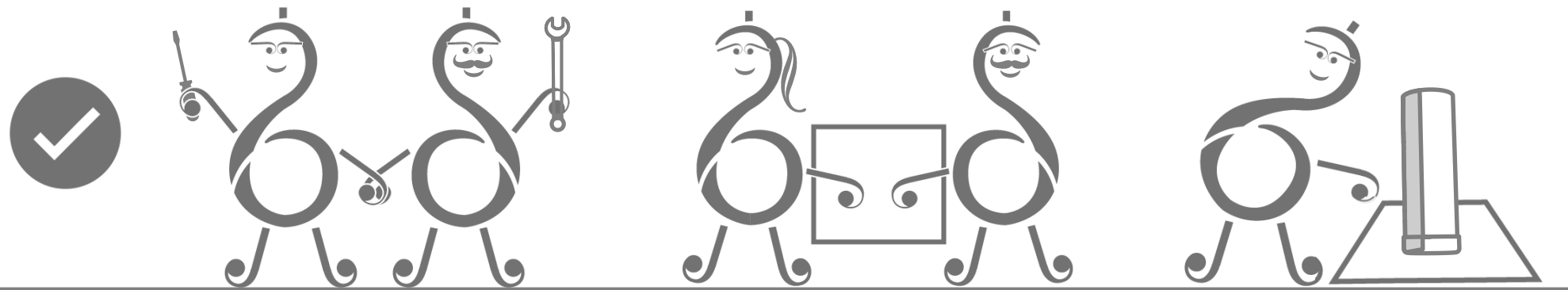

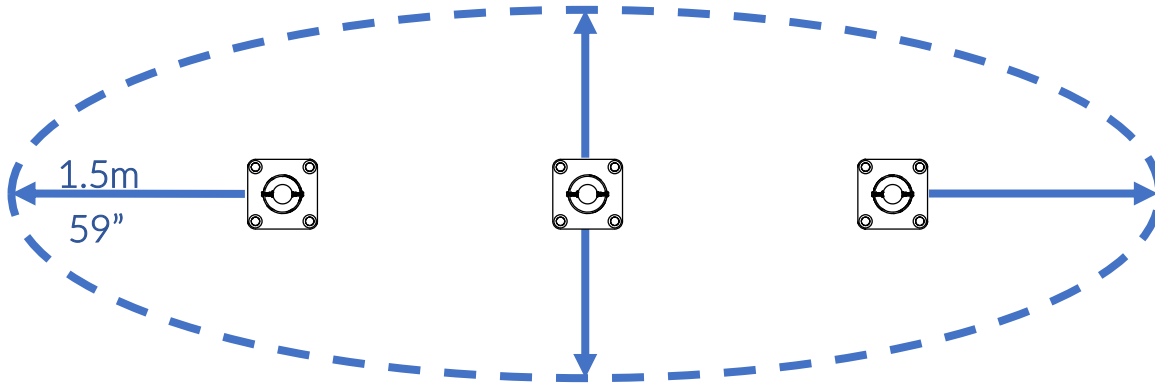



Check Risk Assessment

206cm
81"

251cm
99"

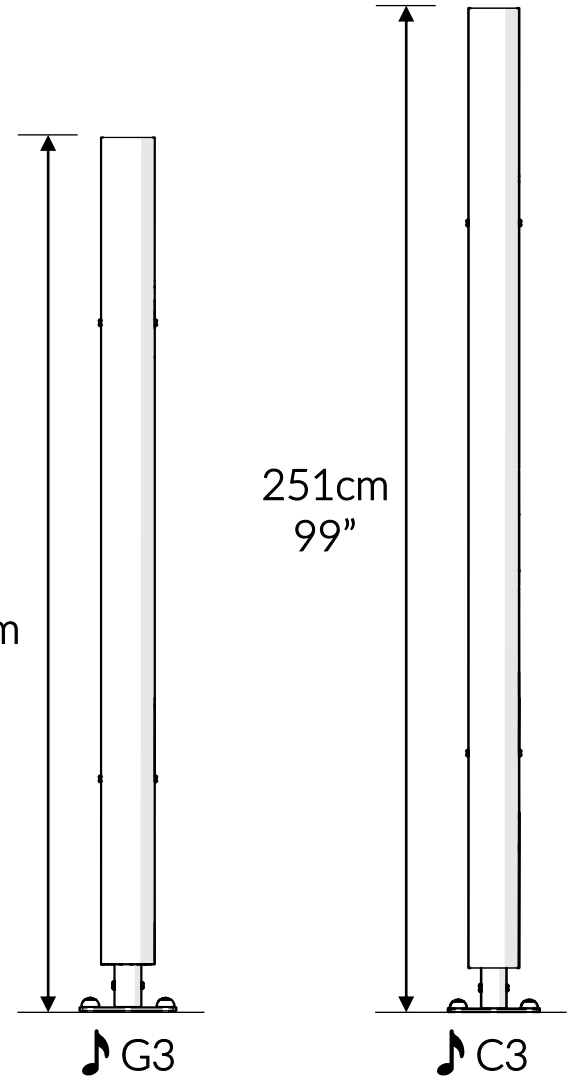

Packages

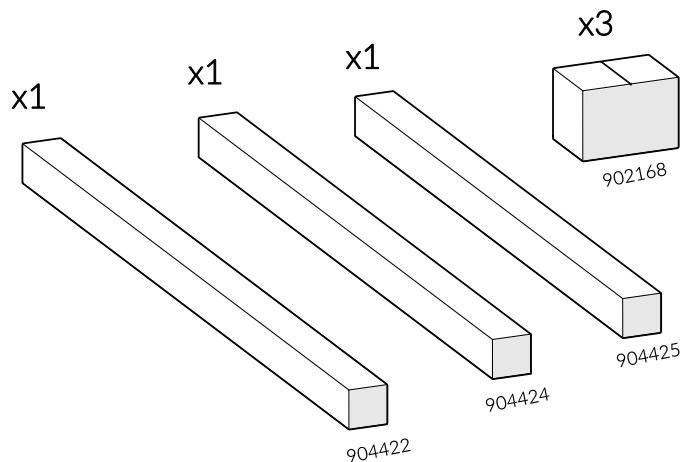

		L	W	H	Weight	Net
x1	904422	250cm / 98.5"	13cm / 5"	13cm / 5"	18kg / 40lbs	
x1	904424	225cm / 88.5"	13cm / 5"	13cm / 5"	16kg / 35lbs	
x1	904425	205cm / 81"	13cm / 5"	13cm / 5"	15kg / 33lbs	
x3	902168	32cm / 12.5"	23cm / 9"	23cm / 9"	6kg / 13lbs	





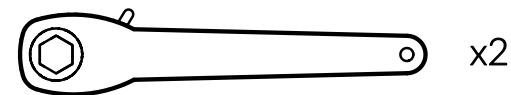

Tools required (not supplied)

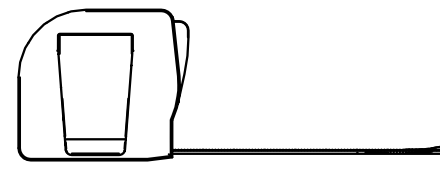
¼" Bit Driver Ratchet

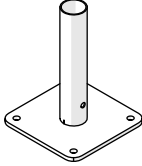
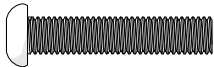

Tape Measure

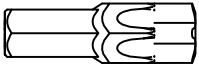

904422	904424	904425	902168	x3
			<p>④ x1 801896</p> 	
			<p>Ⓐ x1 500572</p> 	
			<p>Ⓑ x1 500613</p> 	
			<p>Ⓒ x4 601543</p> 	
			<p>Ⓓ x4 601542</p> 	
<p>① x1 ♩C3</p>	<p>② x1 ♩E3</p>	<p>③ x1 ♩G3</p>	<p>TX45 x2 500720</p> 	

1. x3

1.1

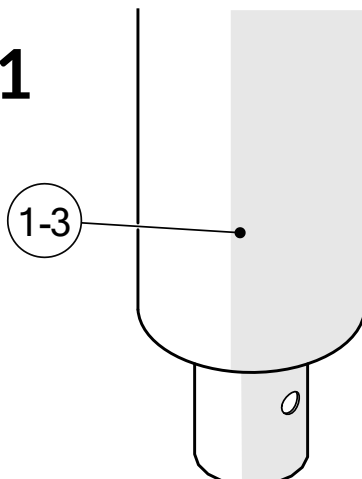

4

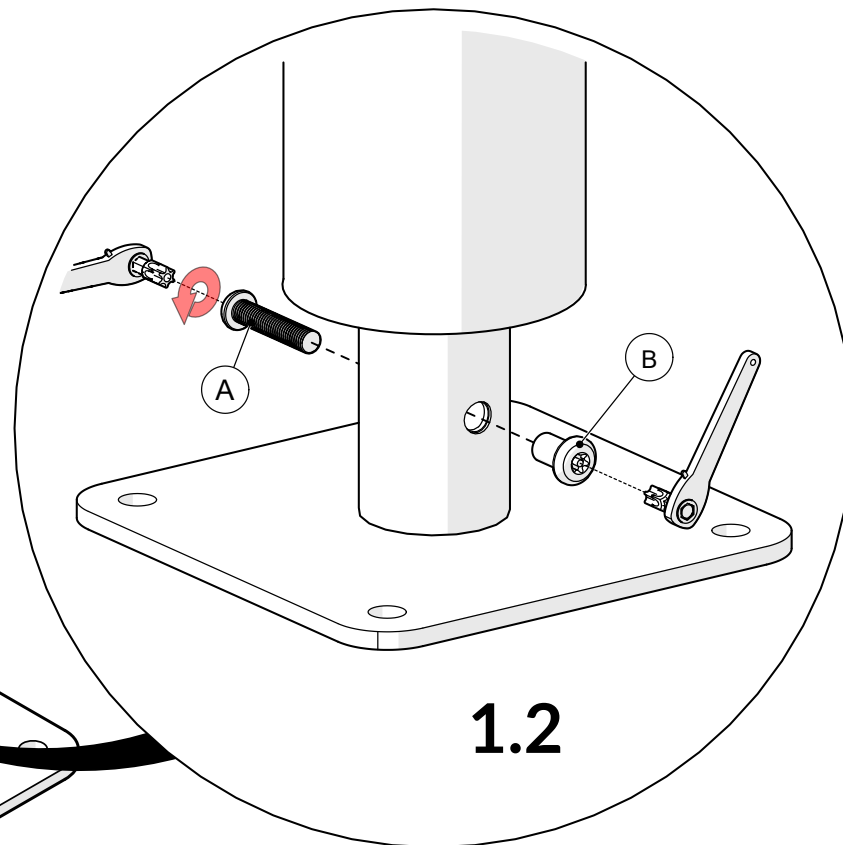

1.2

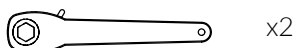

x2

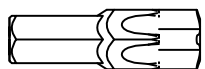

x2 TX45

A		x3
B		x3

2. x3



Surface fixing should not present a hazard

Refer to your local Health & Safety standards

C		x12
D		x12

Surface

Example fixing

	Wood		x12
	Concrete		x12
	Brick		x12

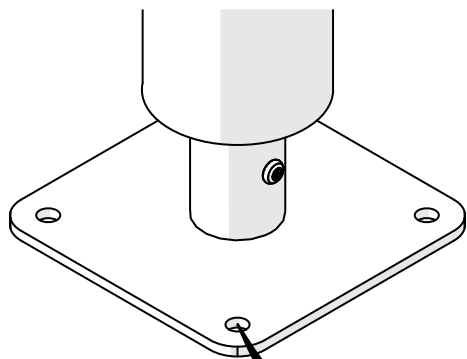

x4

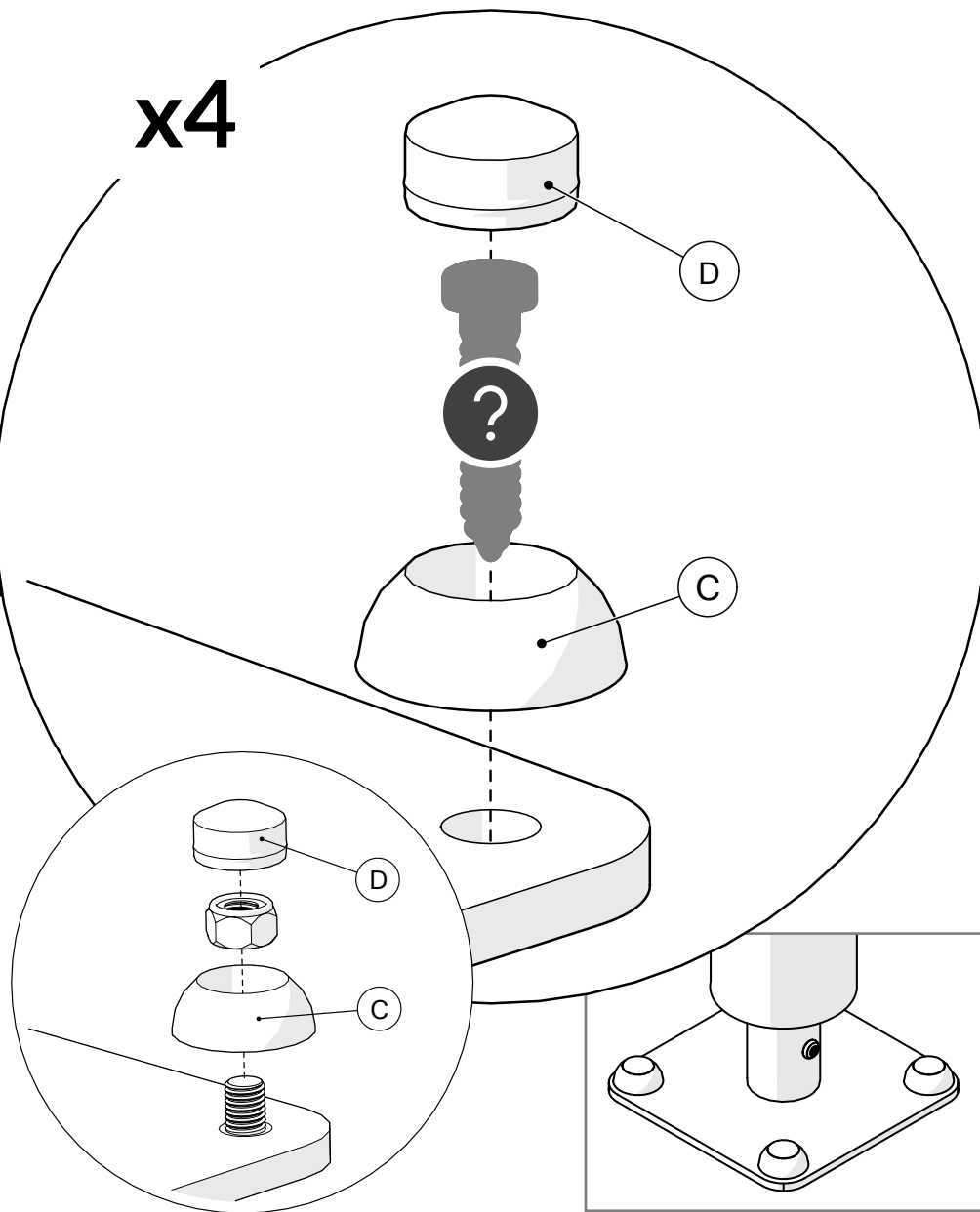

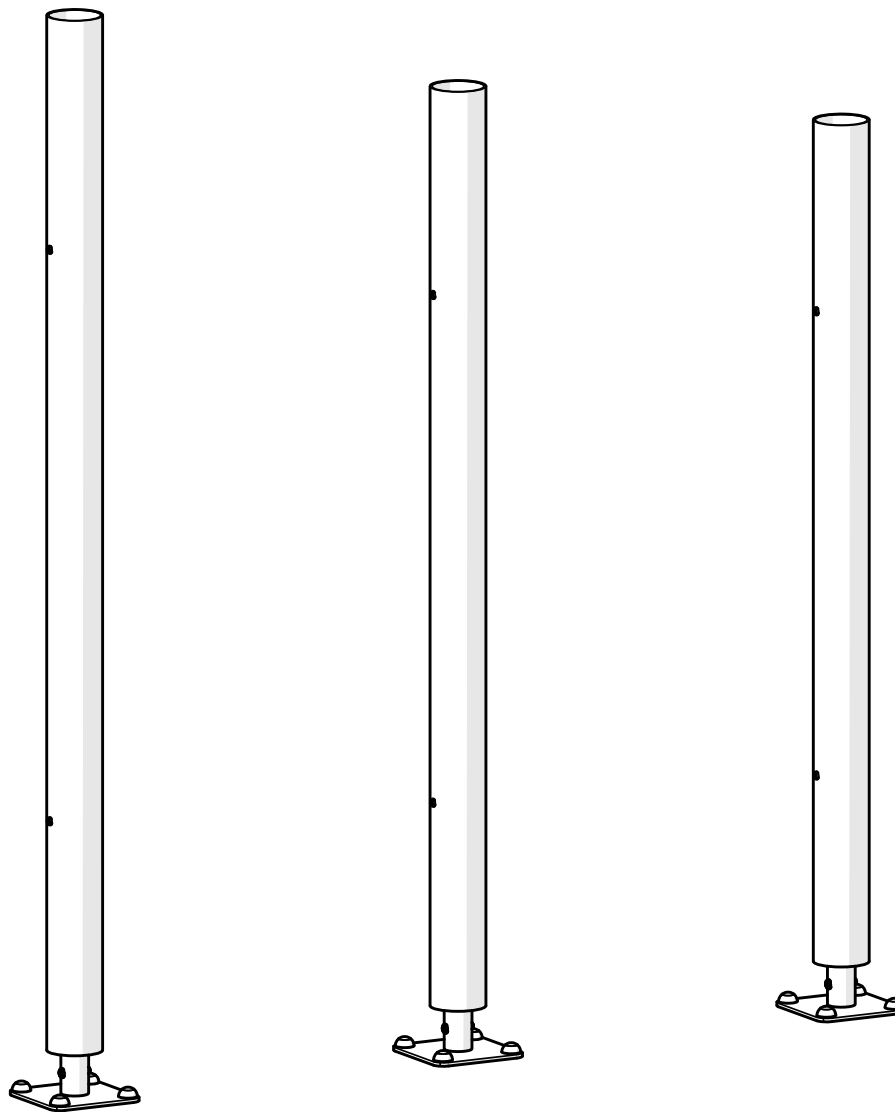

percussionplay.com



info@percussionplay.com



UK
[01730 235 180](tel:01730235180)

USA & CAN
[+1 \(866\) 882 9170](tel:+18668829170)

EUR & ROW
[+44 1730 235 180](tel:+441730235180)