

Part Reference	Description
PP-CALY-S6-PE-GR	Calypso Chimes Pentatonic (Set 6) (Ground Fix)

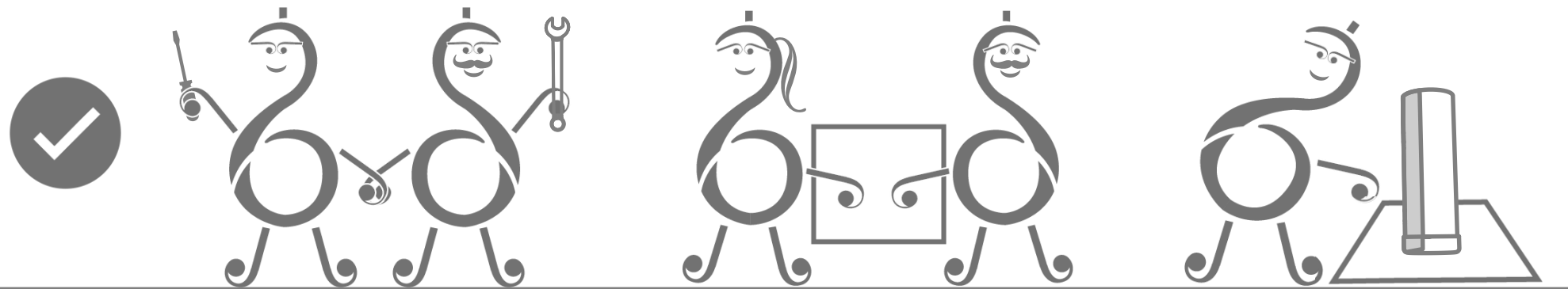

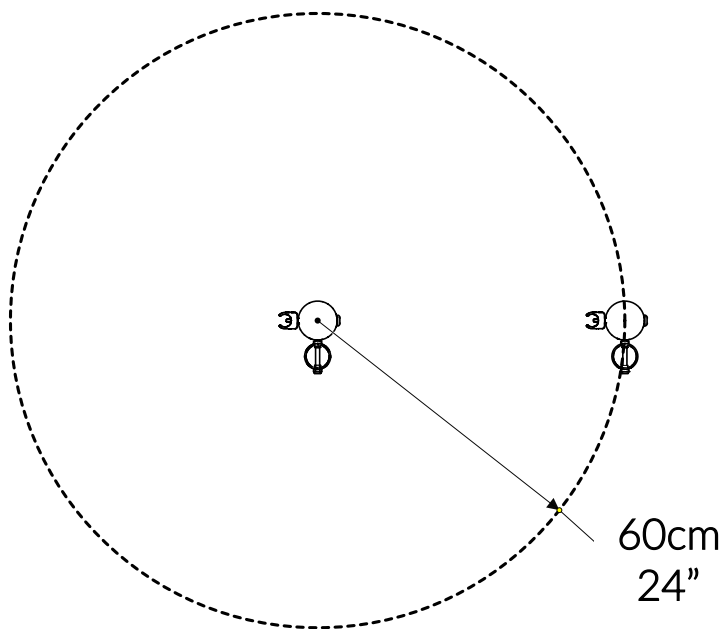

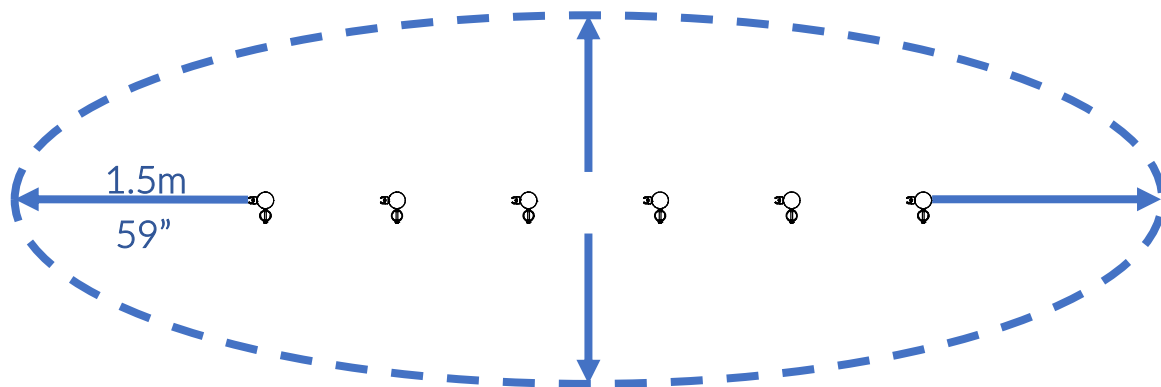

Check Risk Assessment

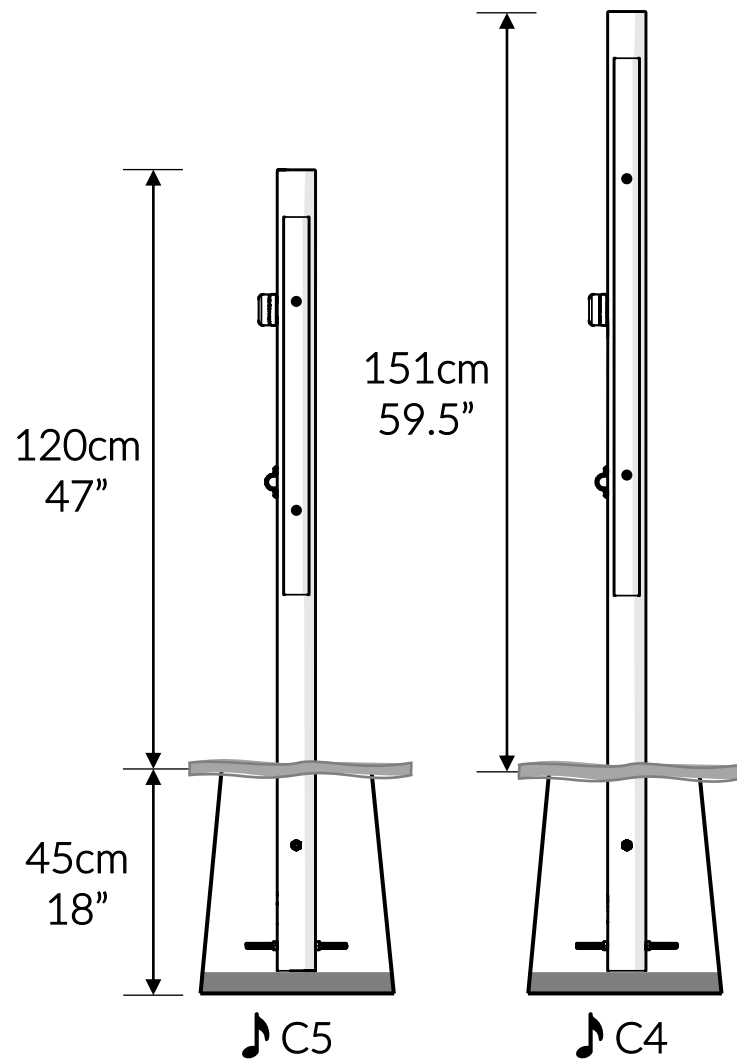

### Packages

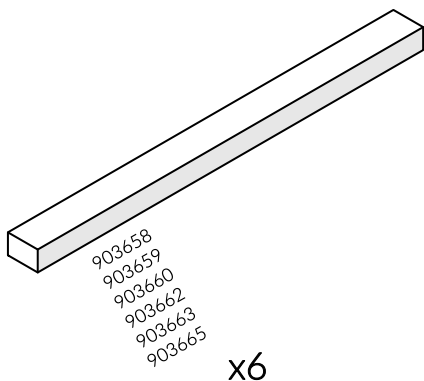

		L	W	H	Weight	Net
x1	903658	194cm / 76"	15cm / 6"	10cm / 4"	7kg / 15.5lbs	
x1	903659					
x1	903660					
x1	903662					
x1	903663					
x1	903665					

### Tools required (not supplied)

¼" Bit Driver Ratchet

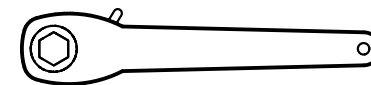

11/16" / 17mm Spanner

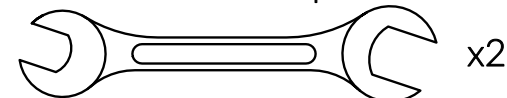

Spirit level

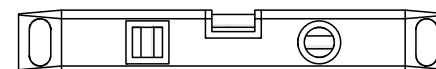

Tape Measure

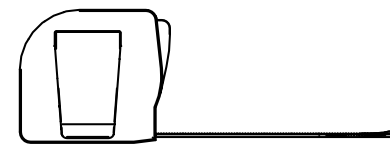

903658

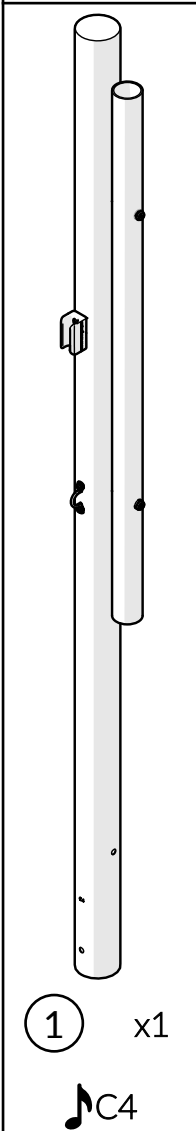

Ⓐ x4  
500457



Ⓑ x2  
500627

Ⓒ x2  
500746



Ⓓ x1  
603150

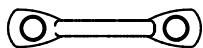

⑦ x1  
900837

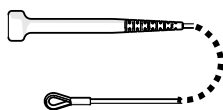

x1  
TX30  
500473



903659

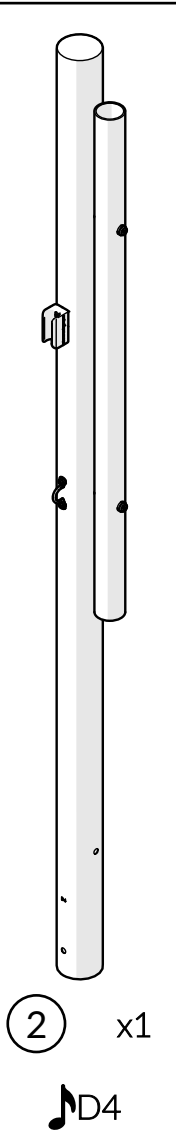

Ⓐ x4  
500457



Ⓑ x2  
500627

Ⓒ x2  
500746

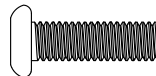

Ⓓ x1  
603150

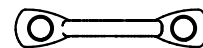



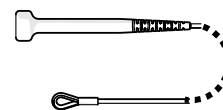





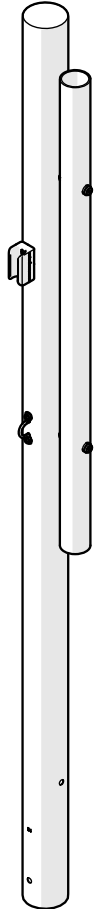





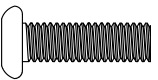
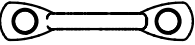
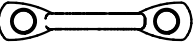
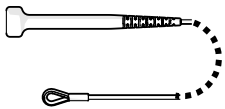
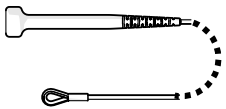
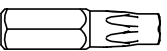



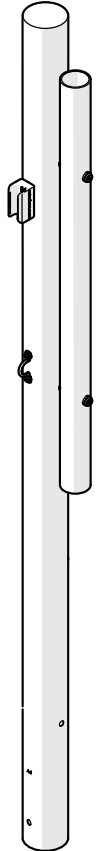

⑦ x1  
900837

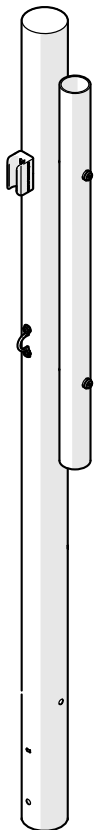

x1  
TX30  
500473

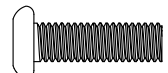

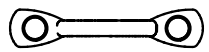
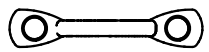
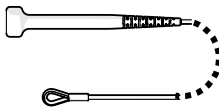
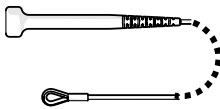
903660			903662		
 <p>③ x1 E4</p>	<p>Ⓐ x4 500457</p> 	<p>Ⓑ x2 500627</p> 	<p>Ⓐ x4 500457</p> 	<p>Ⓑ x2 500627</p> 	
	<p>Ⓒ x2 500746</p> 		<p>Ⓒ x2 500746</p> 		
	<p>Ⓓ x1 603150</p> 		<p>Ⓓ x1 603150</p> 		
	<p>⑦ x1 900837</p> 		<p>⑦ x1 900837</p> 		
	<p>x1 TX30 500473</p> 		<p>x1 TX30 500473</p> 		

903663			903665		
 <p>(5) x1</p> <p>TX30 500473</p> <p> A4</p>	<p>(A) x4</p> <p>500457</p> 	<p>(B) x2</p> <p>500627</p> 	 <p>(6) x1</p> <p>TX30 500473</p> <p> C5</p>	<p>(A) x4</p> <p>500457</p> 	<p>(B) x2</p> <p>500627</p> 
	<p>(C) x2</p> <p>500746</p> 	<p>(C) x2</p> <p>500746</p> 			
	<p>(D) x1</p> <p>603150</p> 	<p>(D) x1</p> <p>603150</p> 			
	<p>(7) x1</p> <p>900837</p> 	<p>(7) x1</p> <p>900837</p> 			
	<p>x1</p> <p>TX30 500473</p> 	<p>x1</p> <p>TX30 500473</p> 			

# 1. x6

1.1

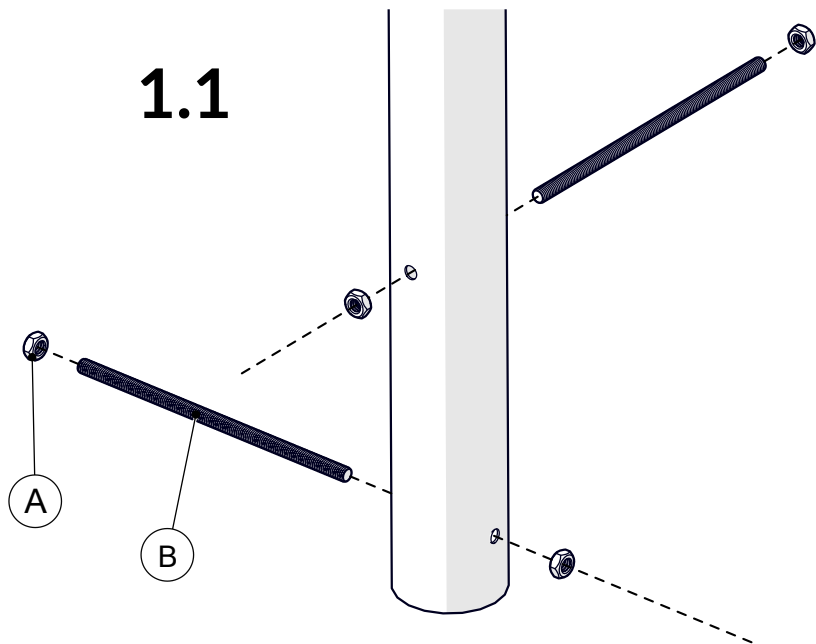

1.2

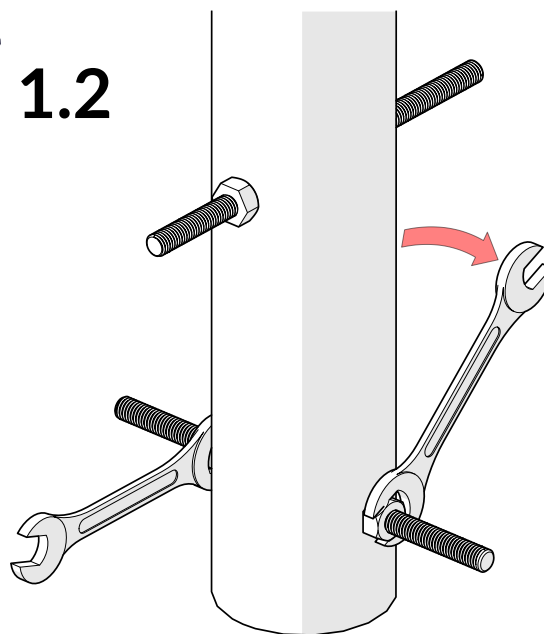

1.3

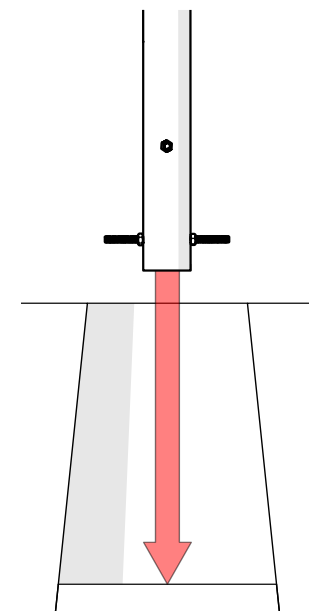

A		x24
B		x12

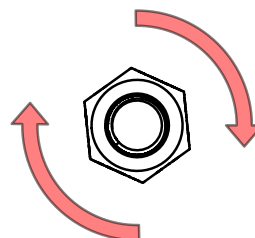



# 2. x6



Foundations should not present a hazard

Refer to your local Health & Safety standards

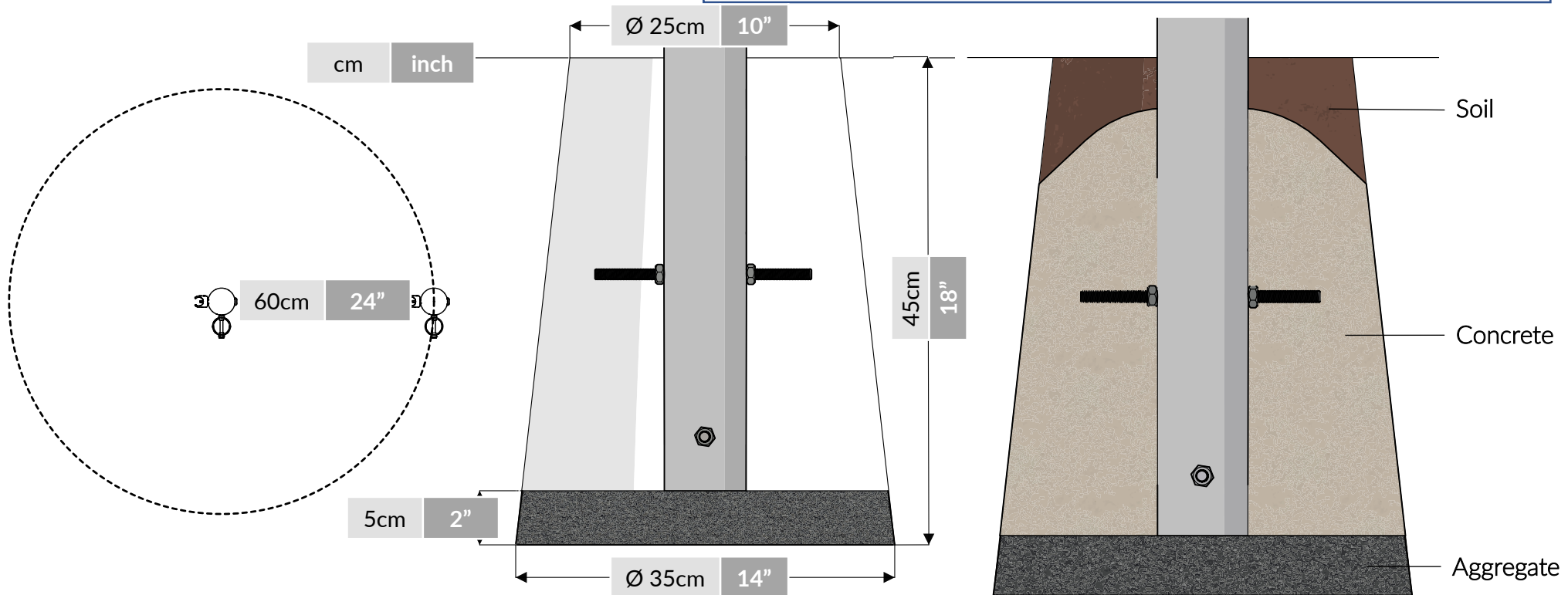
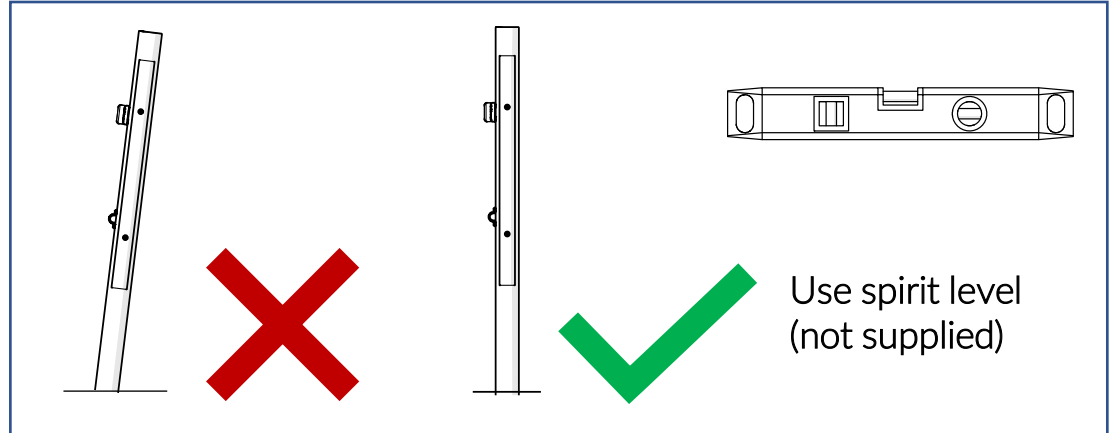

# 3. x6



TX30

7		x6
C		x12
D		x6

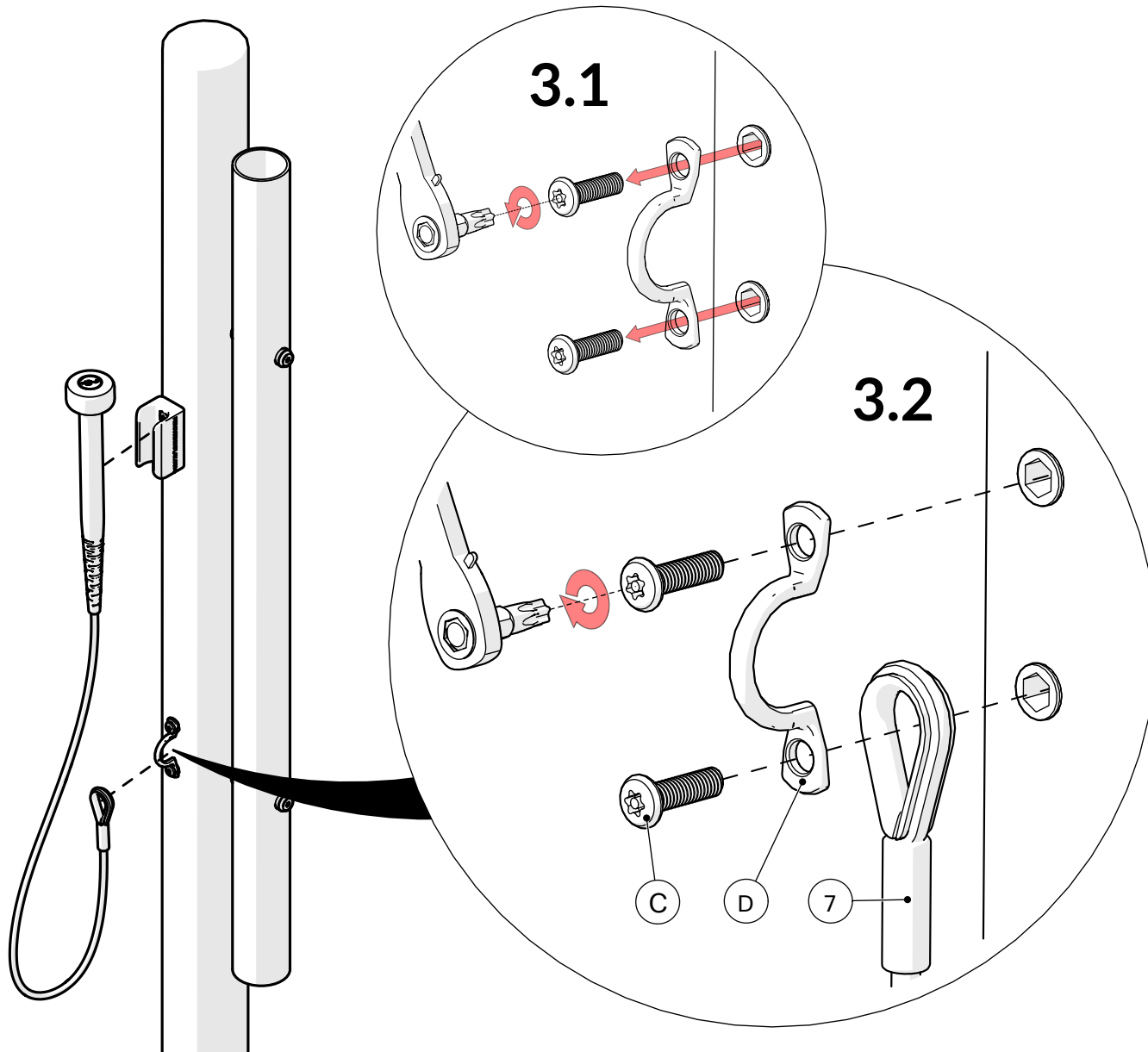

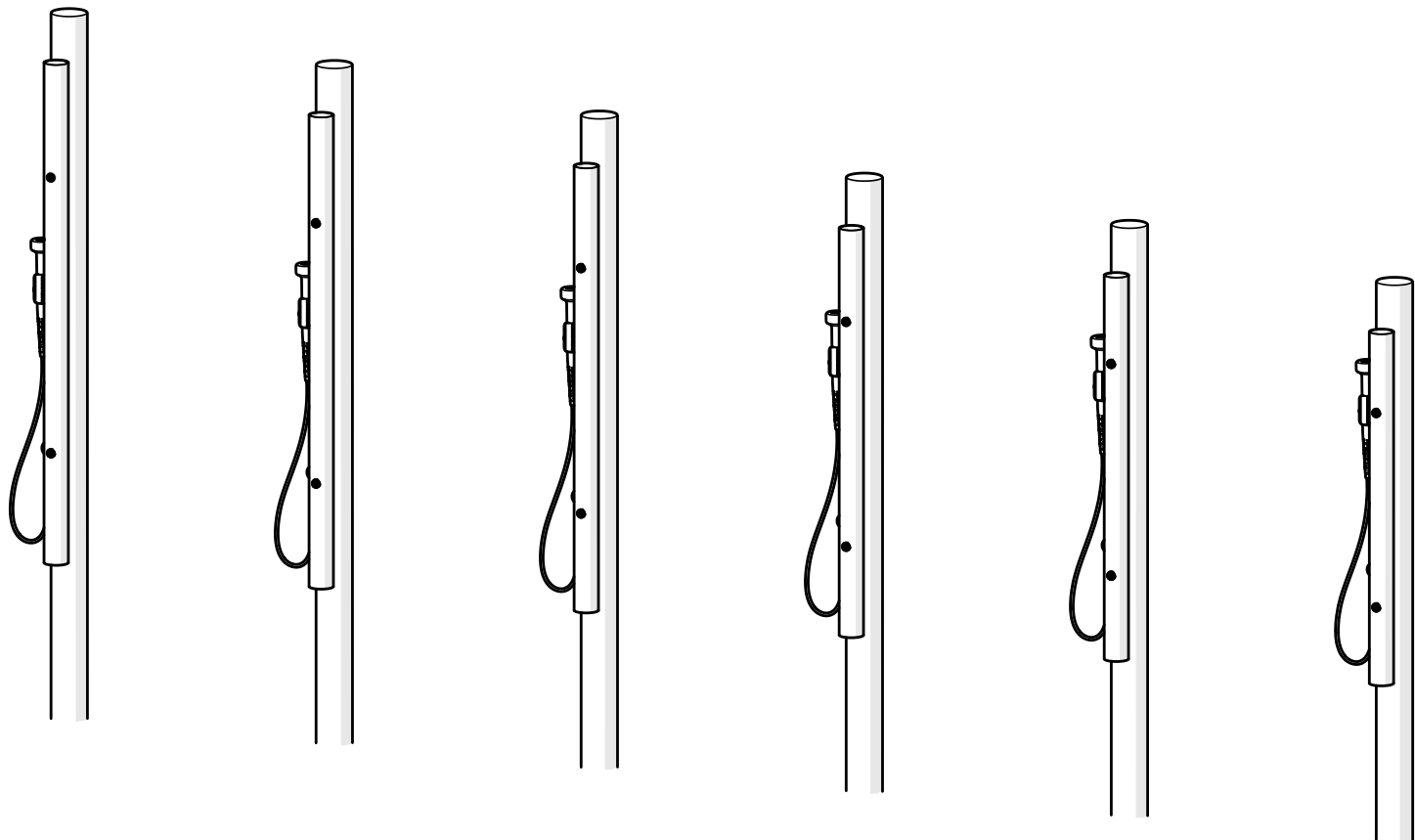

[percussionplay.com](http://percussionplay.com)



[info@percussionplay.com](mailto:info@percussionplay.com)



UK  
[01730 235 180](tel:+441730235180)

USA & CAN  
[+1 \(866\) 882 9170](tel:+18668829170)

EUR & ROW  
[+44 1730 235 180](tel:+441730235180)

Layout for illustration purposes only