

Part Reference	Description
PP-RAIN-BON-SU	Rainbow Trio Bongos (Surface Fix)

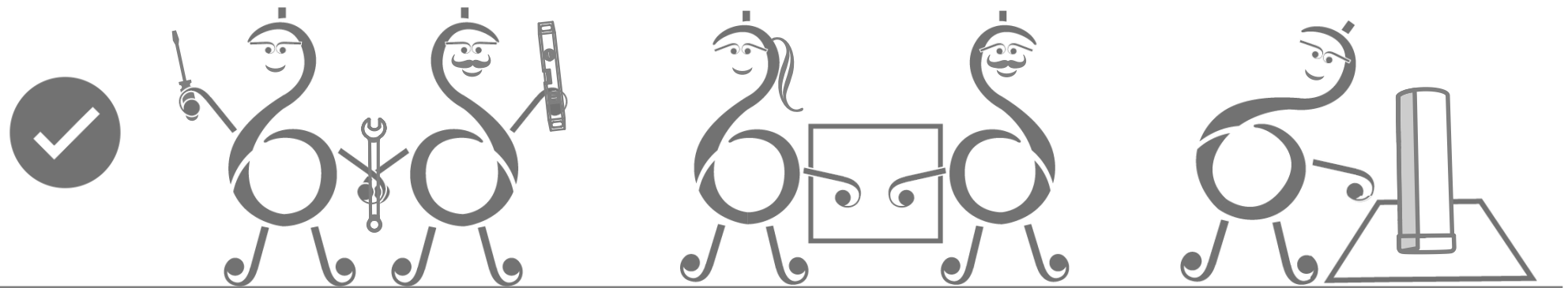

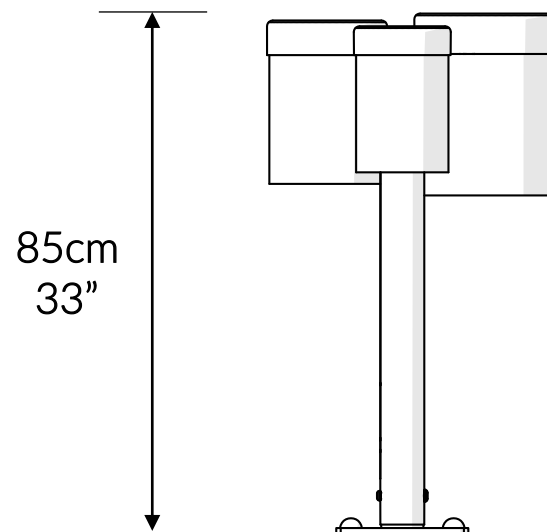

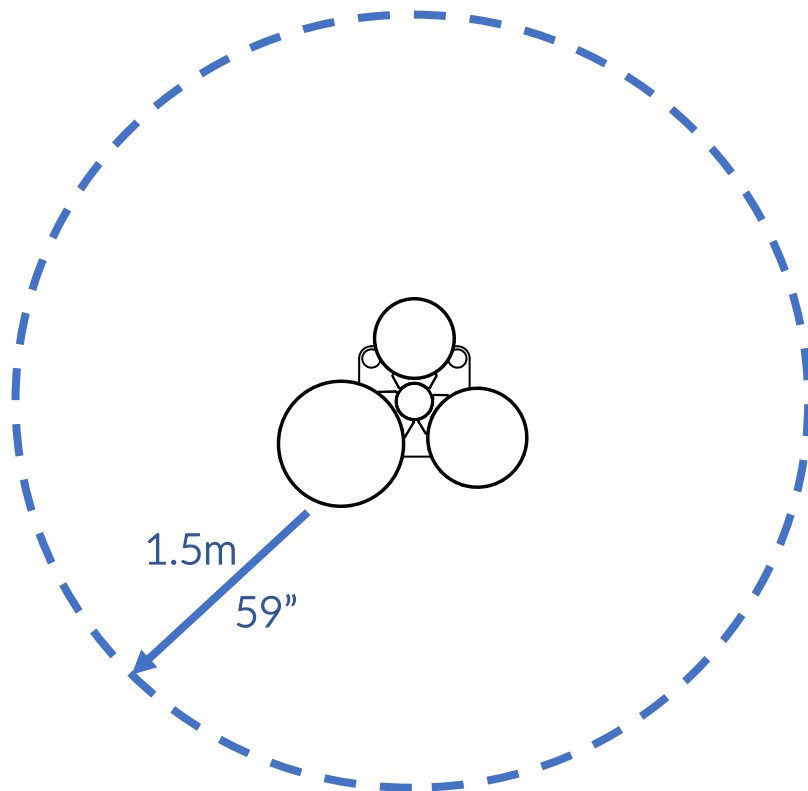

Check Risk Assessment

Packages

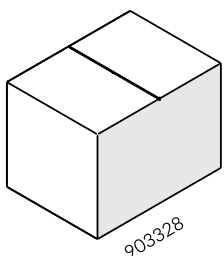

x1

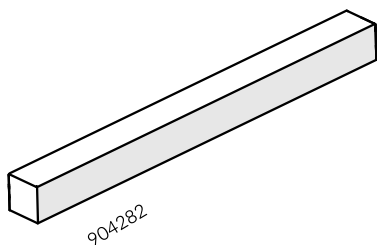

x1

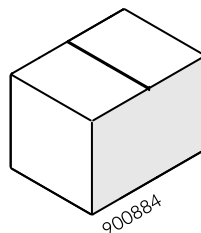

x1

		L	W	H	Weight	Net
x1	903328	38cm / 15"	28cm / 11"	28cm / 11"	8kg / 18lbs	
x1	904282	115cm / 45"	11cm / 4"	11cm / 4"	4kg / 9lbs	
x1	900884	23cm / 9"	23cm / 9"	31cm / 12"	6kg / 13lbs	

Tools required (not supplied)

¼" Bit Driver Ratchet

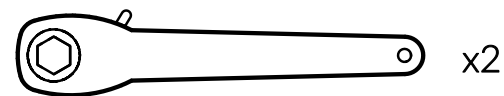

x2

Tape Measure

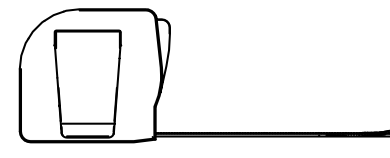

903328

(A) x4
600733

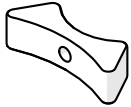

(1) x1
Ø 160mm/6"

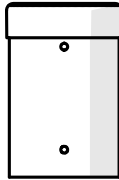

(B) x2
600732

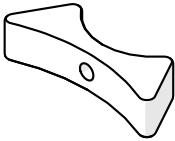

(2) x1
Ø 200mm/8"

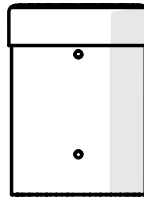

(C) x6
500572

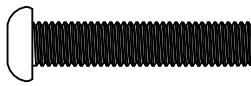

(3) x1
Ø 250mm/10"

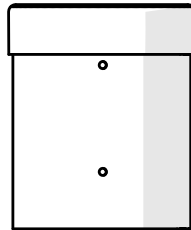

(D) x6
500685

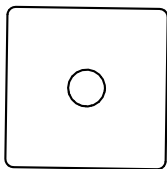

TX45 x1
500720

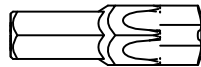

904282

(4) x1
804278



Not to scale

900884

(5) x1
800878

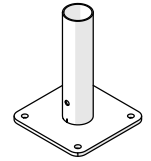

(E) x1
500667



(F) x1
500613

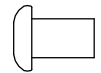

(G) x4
601543

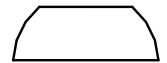

(H) x4
601542



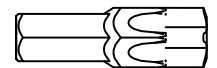

TX45 x2
500720

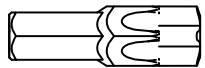

1.

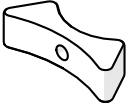

TX45

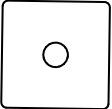

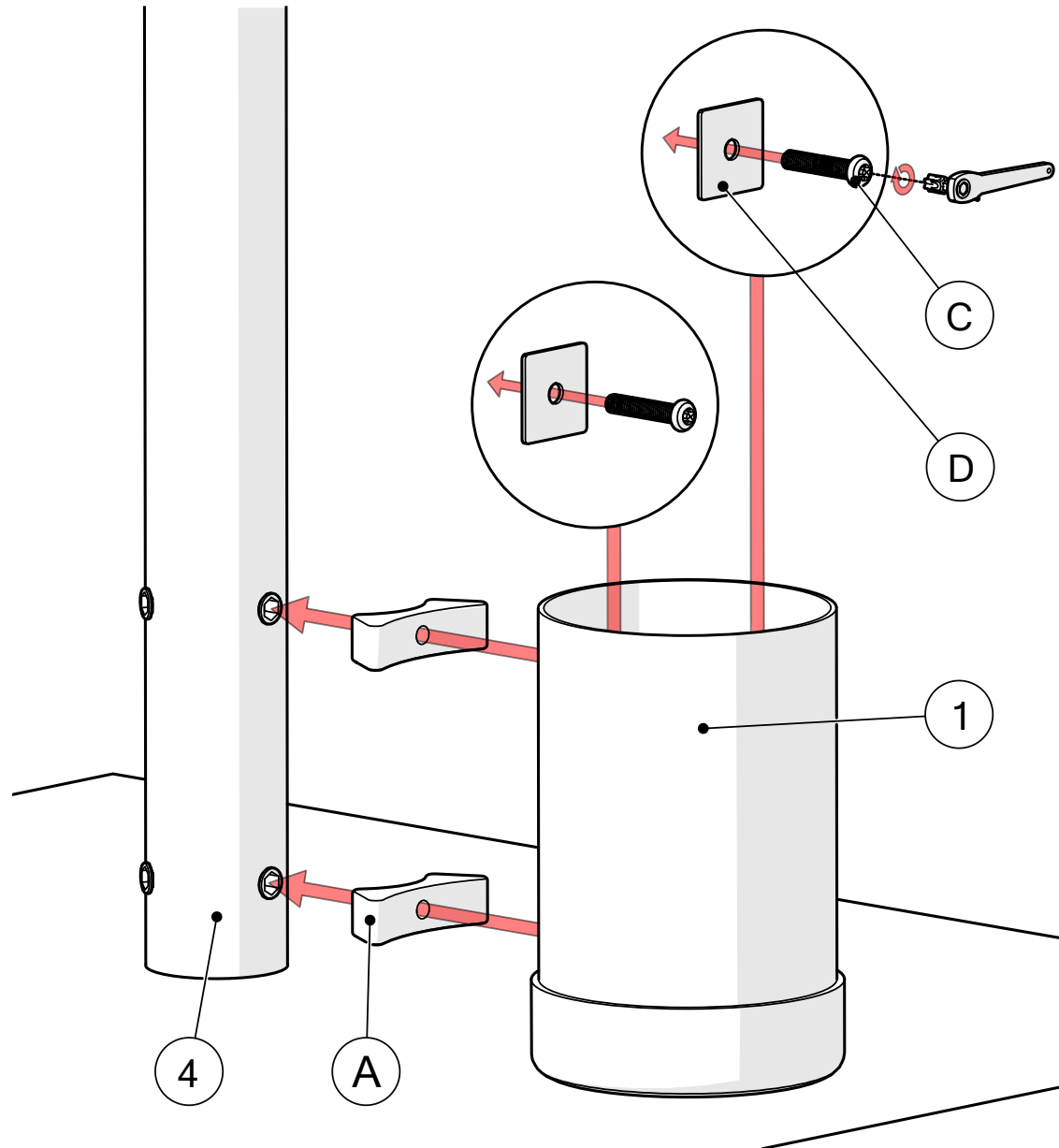
A		x2
C		x2
D		x2

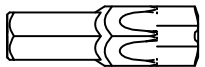

2.

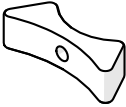

TX45

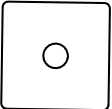

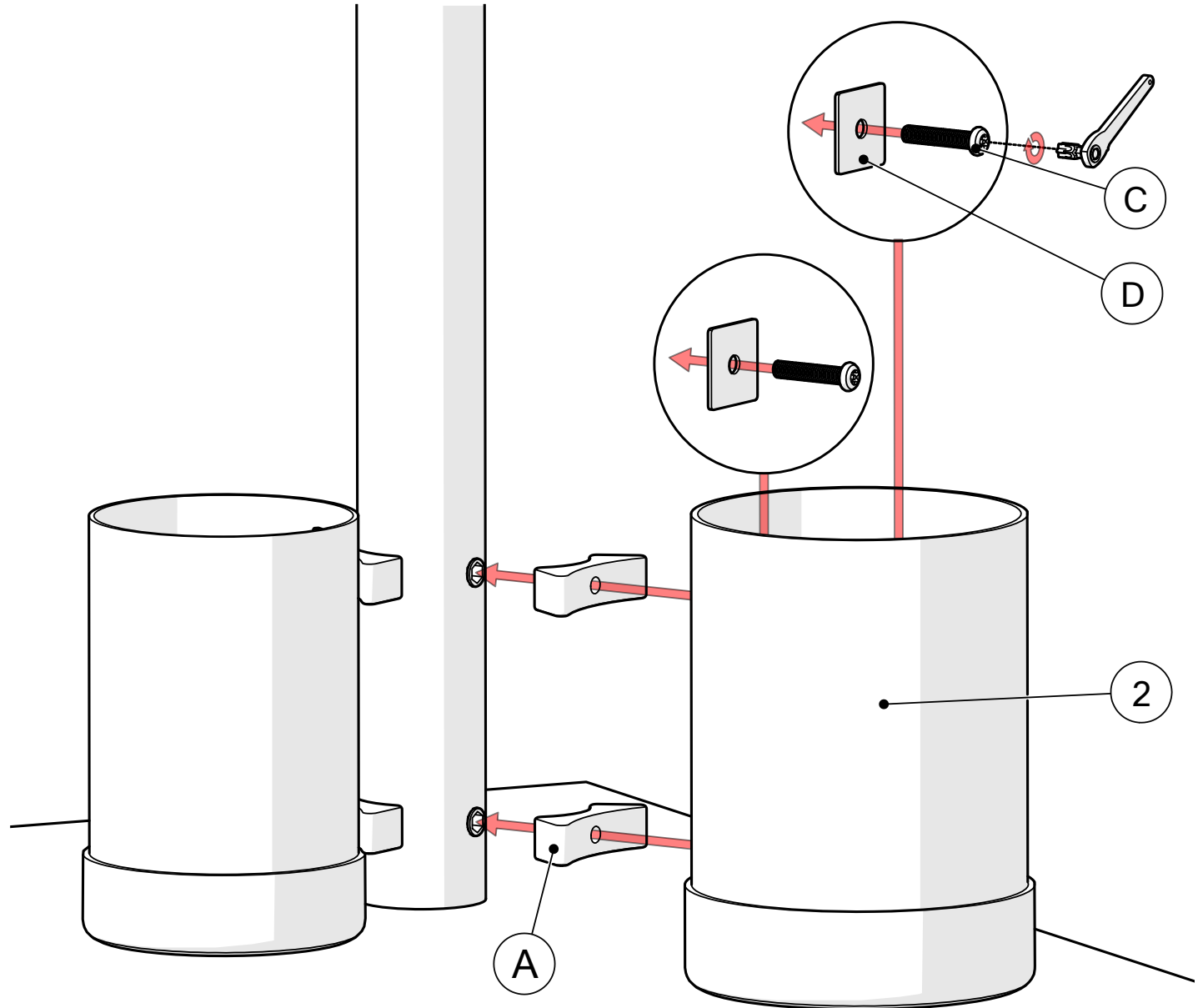
A		x2
C		x2
D		x2

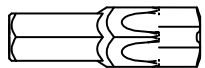

3.

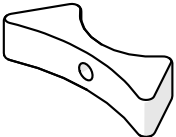

TX45

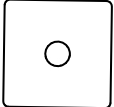
B		x2
C		x2
D		x2

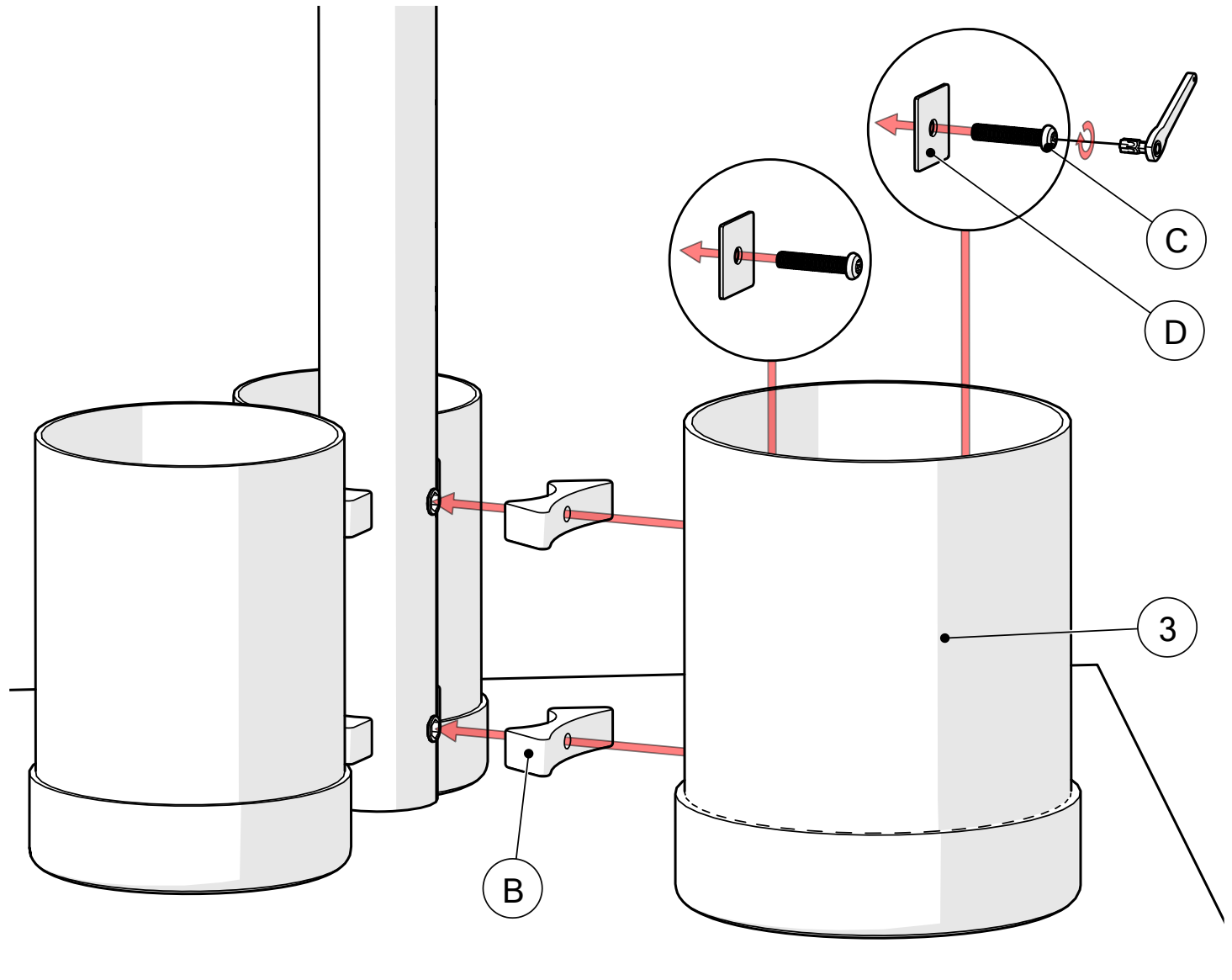

4.

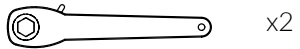

x2

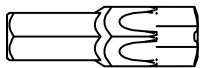

x2 TX45

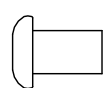
E		x1
F		x1

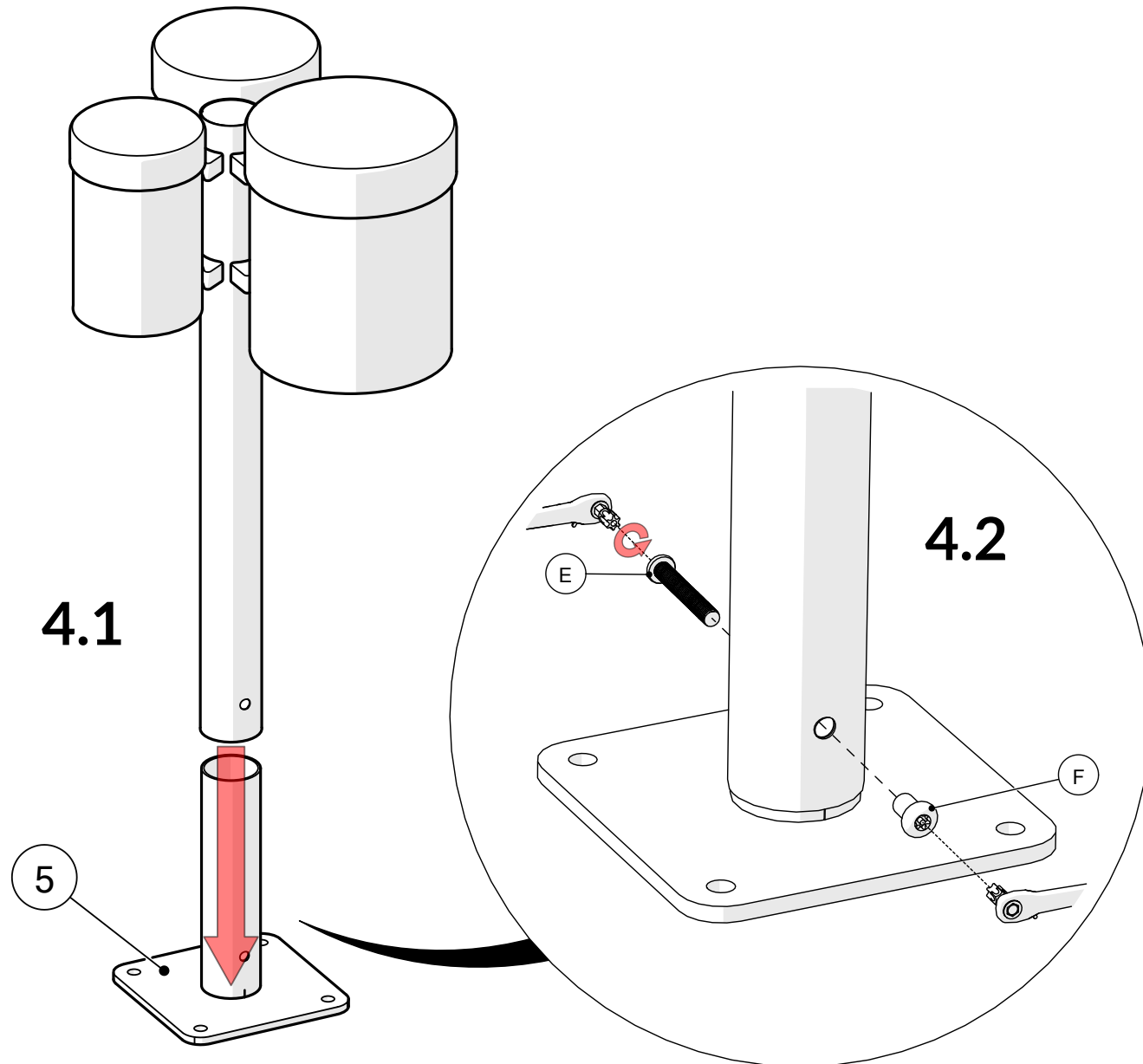



5.

Surface fixing should not present a hazard







Refer to your local Health & Safety standards

G		x4
H		x4

Surface

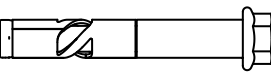
Example fixing

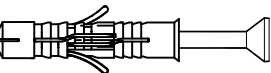
	Wood		x4
	Concrete		x4
	Brick		x4

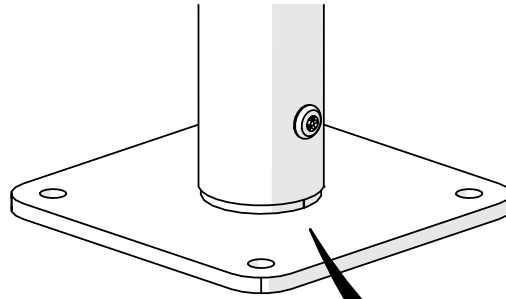

x4

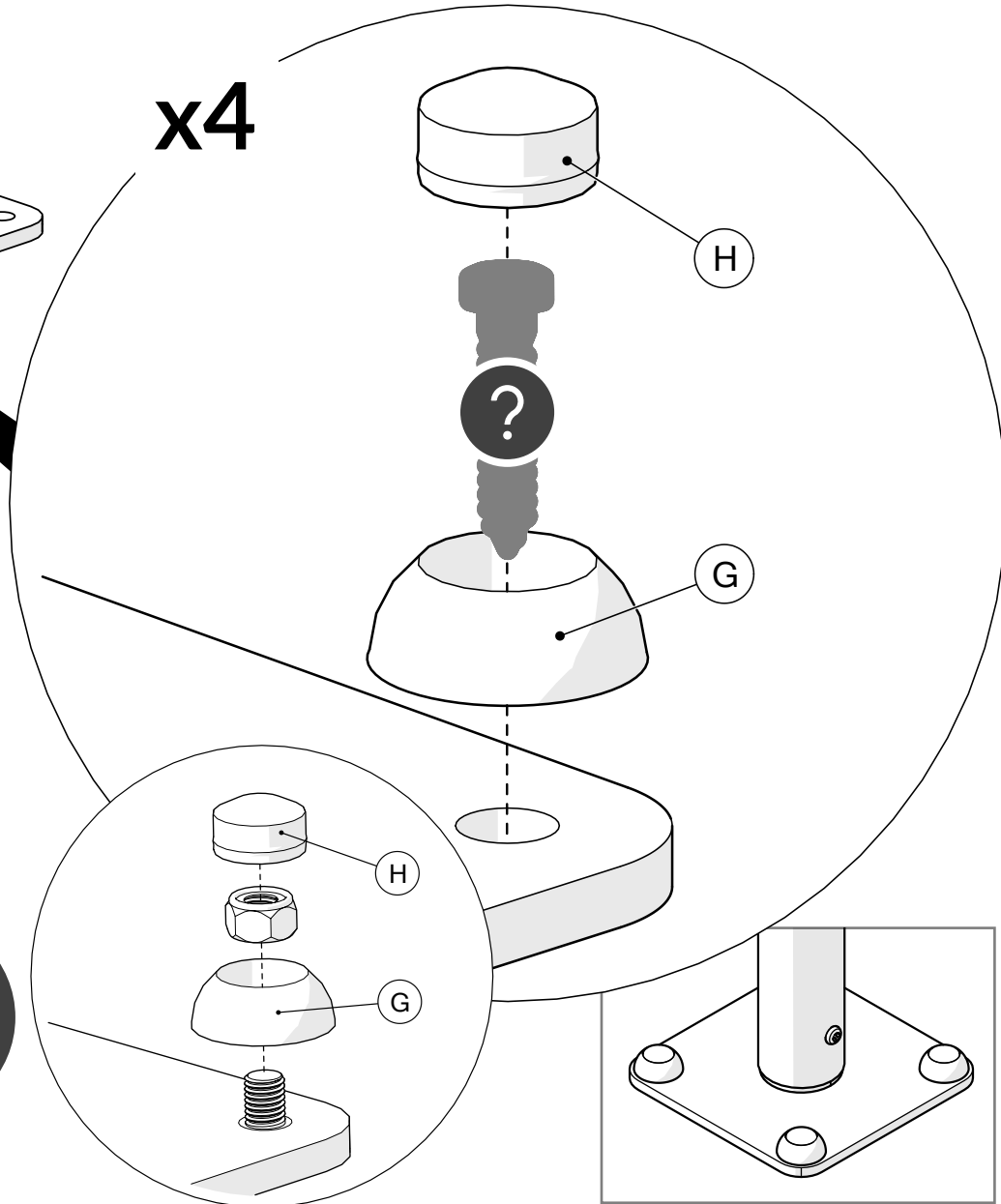

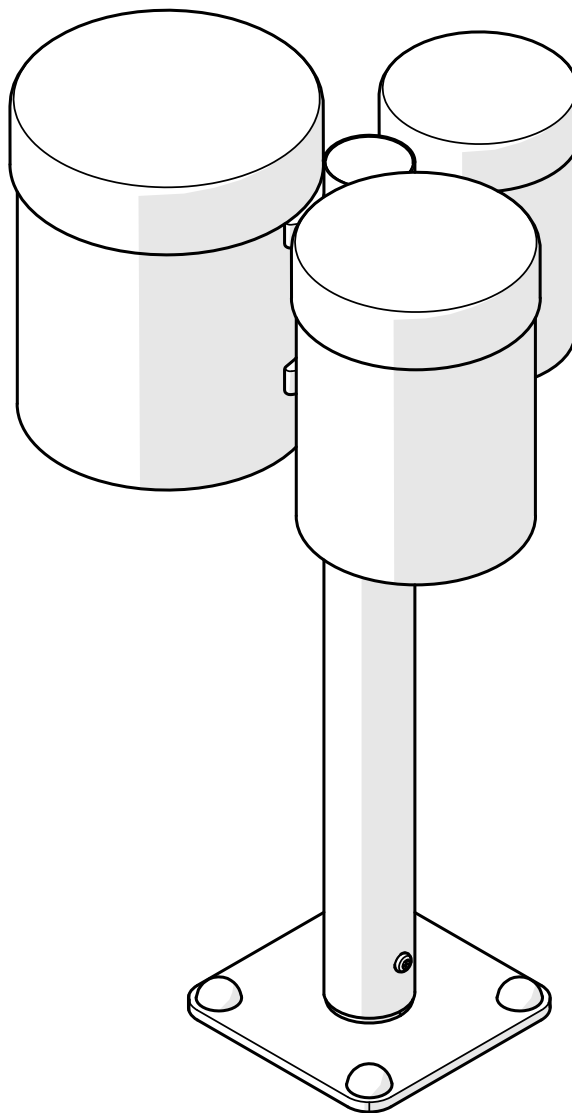

percussionplay.com



info@percussionplay.com



UK
[01730 235 180](tel:01730235180)

USA & CAN
[+1 \(866\) 882 9170](tel:+18668829170)

EUR & ROW
[+44 1730 235 180](tel:+441730235180)