

Part Reference	Description
PP-CHER-SD-SU	Cherub (Surface Fix)
PP-CHER-HD-SU	Heavy Duty Cherub (Surface Fix)

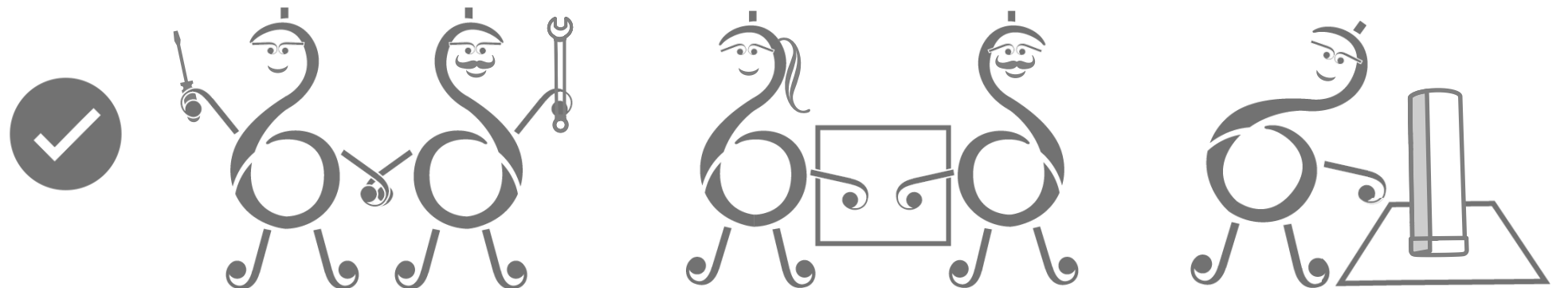

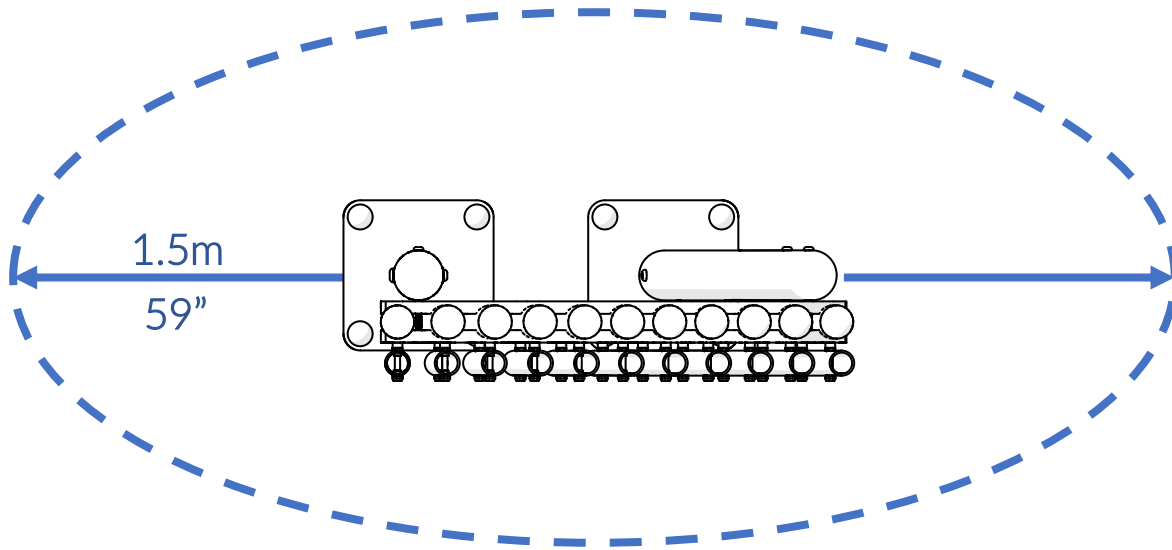



Check Risk Assessment

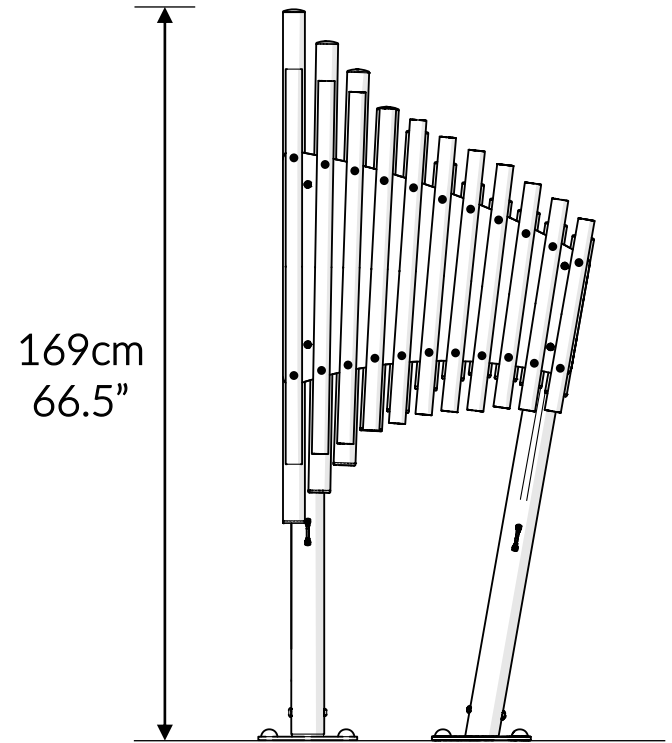

Packages

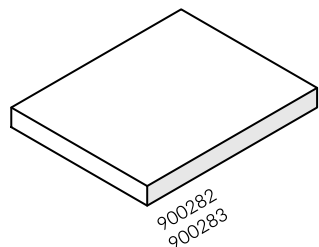

x1

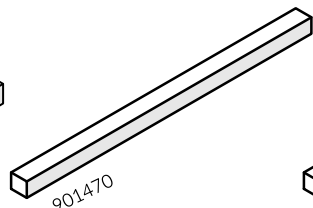

x1

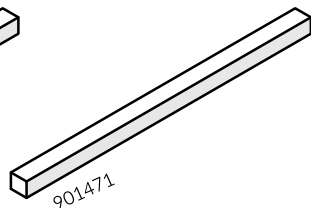

x1

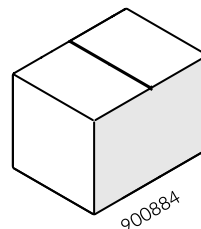

x1

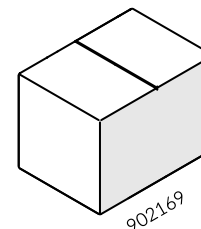

x1

		L	W	H	Weight	Net
x1	900282	100cm / 39"	80cm / 31"	10cm / 4"	30kg / 66lbs	
	900283				40kg / 88lbs	
x1	901470	200cm / 79"	11cm / 4"	10cm / 4"	6kg / 13lbs	
x1	901471	200cm / 79"	11cm / 4"	10cm / 4"	6kg / 13lbs	
x1	900884	23cm / 9"	23cm / 9"	31cm / 12"	6kg / 13lbs	
x1	902169	23cm / 9"	23cm / 9"	31cm / 12"	6kg / 13lbs	

Tools required (not supplied)

¼" Bit Driver Ratchet



¼" hex adapter

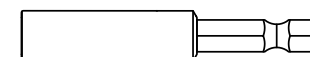

Spirit level

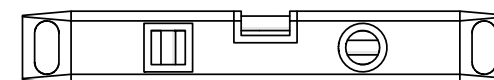

Tape Measure

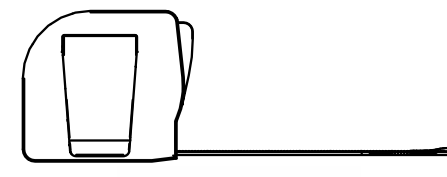

900282
900283

① x1

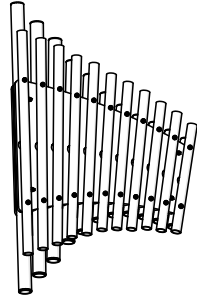

② x2

900837



Ⓐ x4
501586

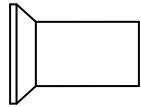

Ⓑ x4
501591



Ⓒ x4
500890

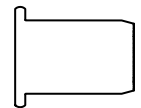

Ⓓ x4
501412

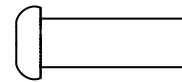

TX30 x1
500473



TX40 x1
500474

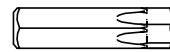

901470

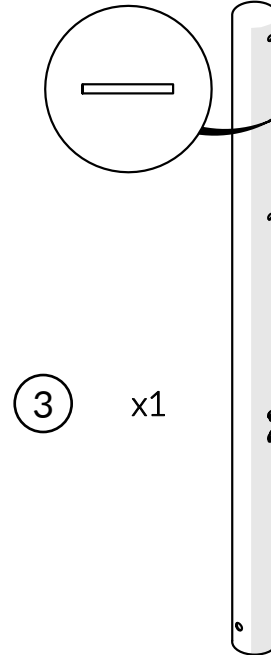

③ x1

901471

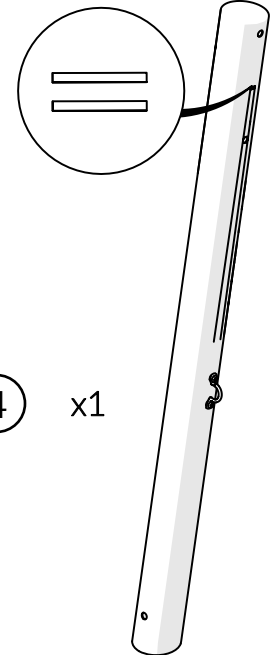

④ x1

Ⓘ x1
603150

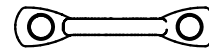

Ⓘ x1
603150

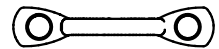



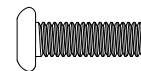



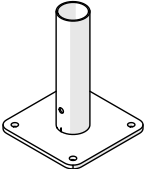
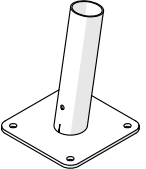

Ⓙ x2
500746

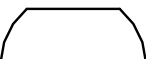
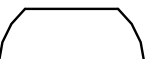

Ⓙ x2
500746



900884	902169
<p>(5) x1 800878</p> 	<p>(6) x1 801902</p> 
<p>(E) x1 500667</p> 	<p>(E) x1 500667</p> 
<p>(F) x1 500613</p> 	<p>(F) x1 500613</p> 
<p>(G) x4 601543</p> 	<p>(G) x4 601543</p> 
<p>(H) x4 601542</p> 	<p>(H) x4 601542</p> 
<p>TX45 x2 500720</p> 	<p>TX45 x2 500720</p> 

Not to scale

1.

1.1

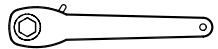
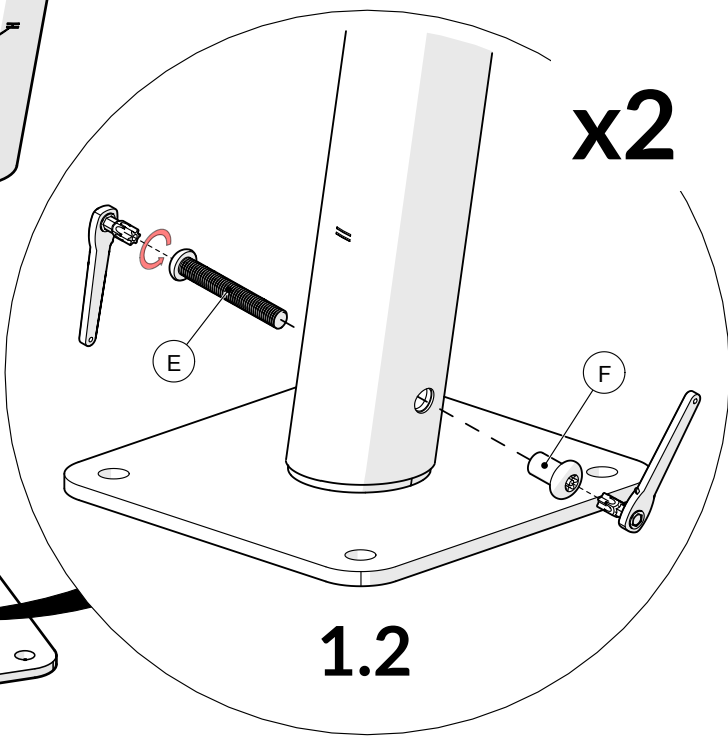
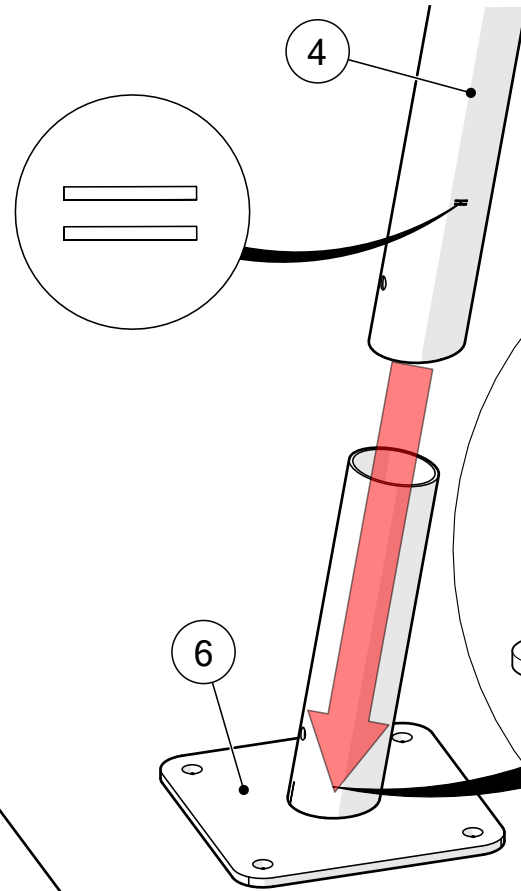
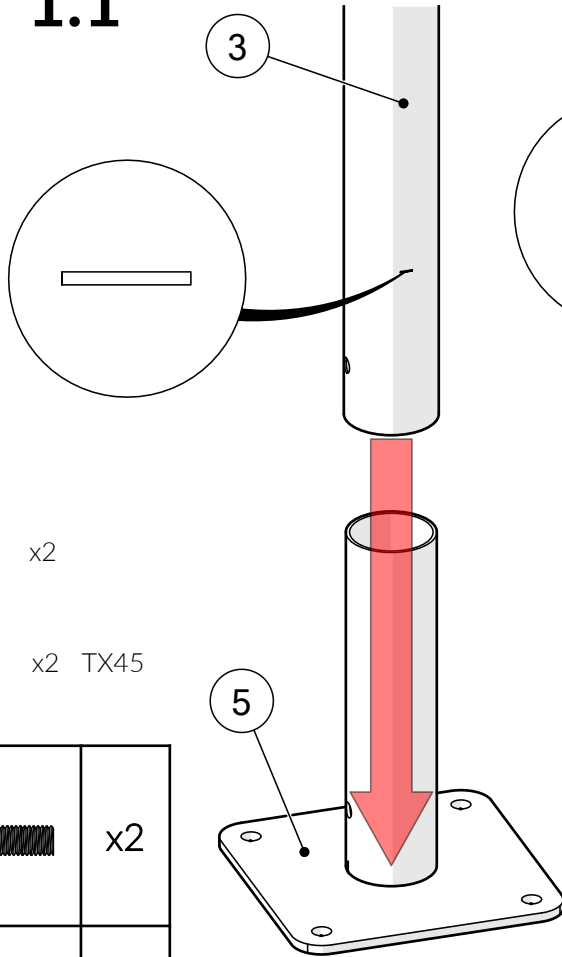

x2

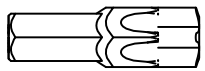

x2 TX45

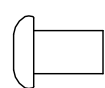
E		x2
F		x2

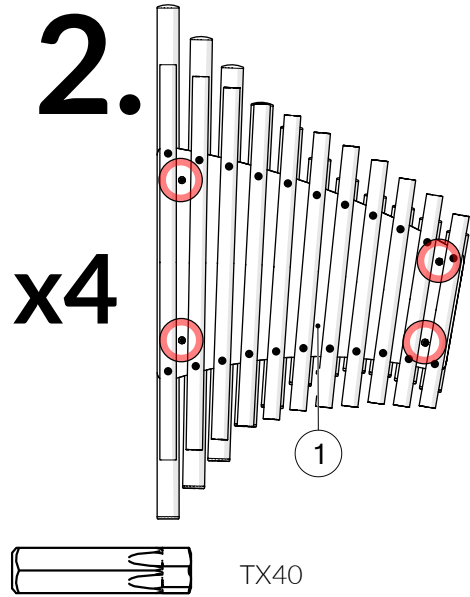

A		x4
B		x4
C		x4

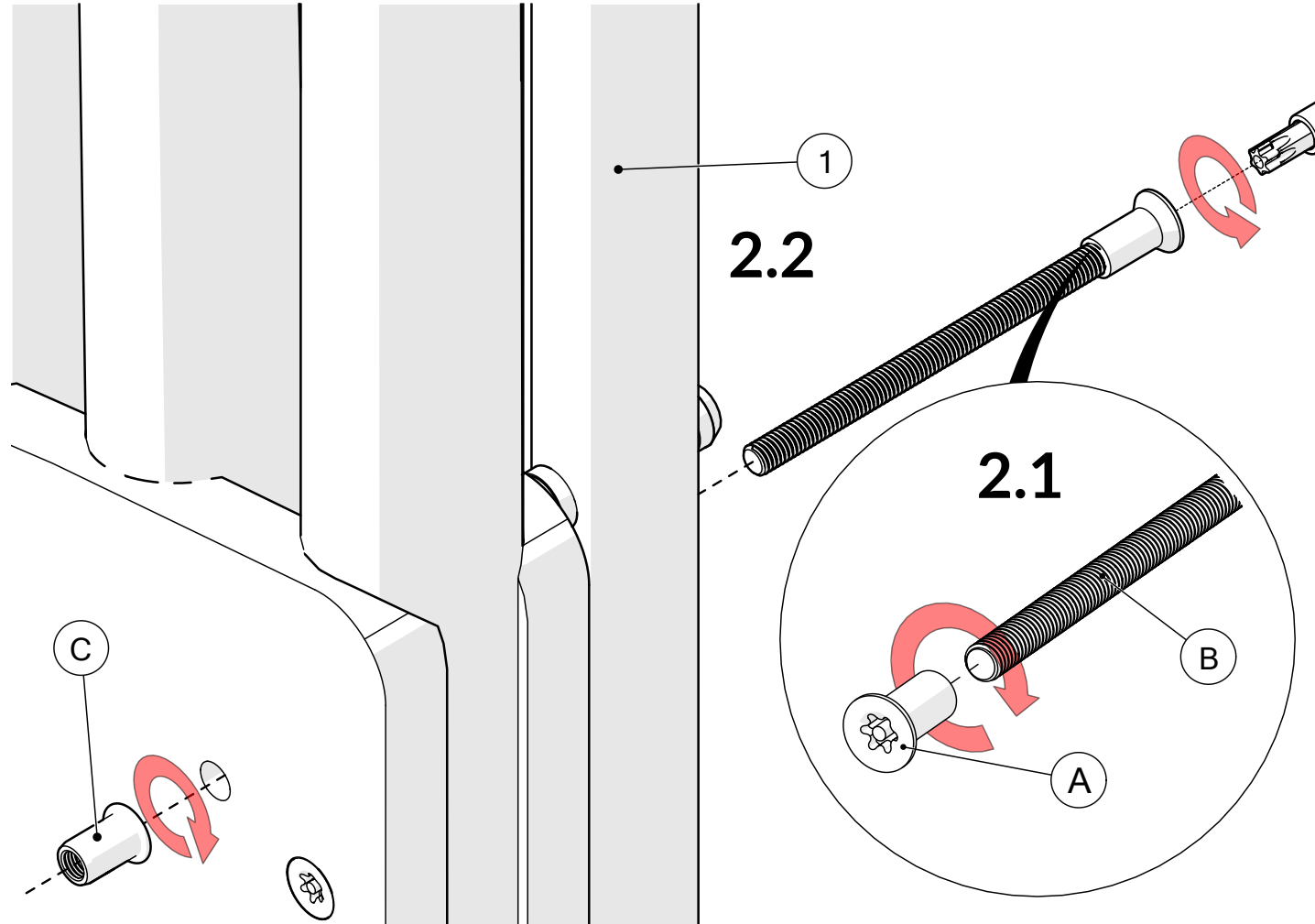

3.

3.1

3.2

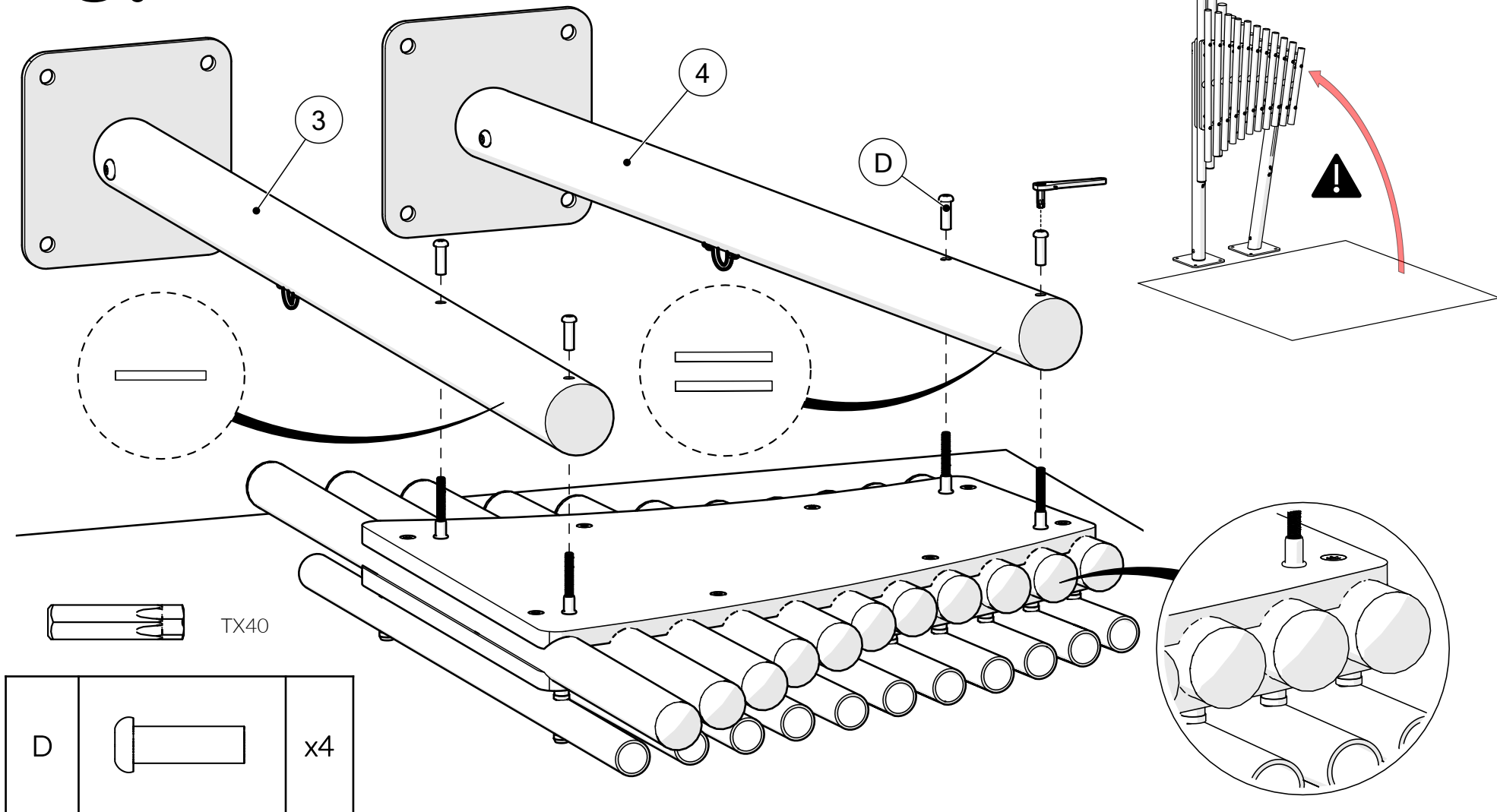



4.

Surface fixing should not present a hazard







Refer to your local Health & Safety standards

G		x8
H		x8

Surface

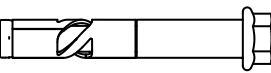
Example fixing

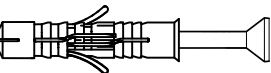
	Wood		x8
	Concrete		x8
	Brick		x8

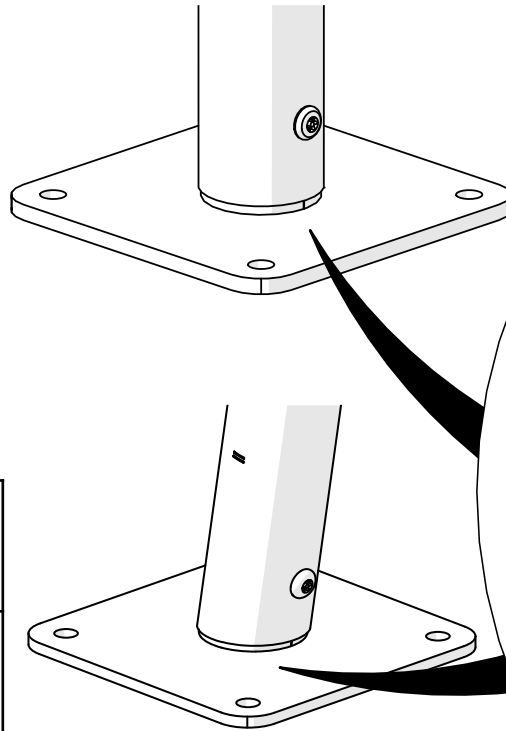

x8

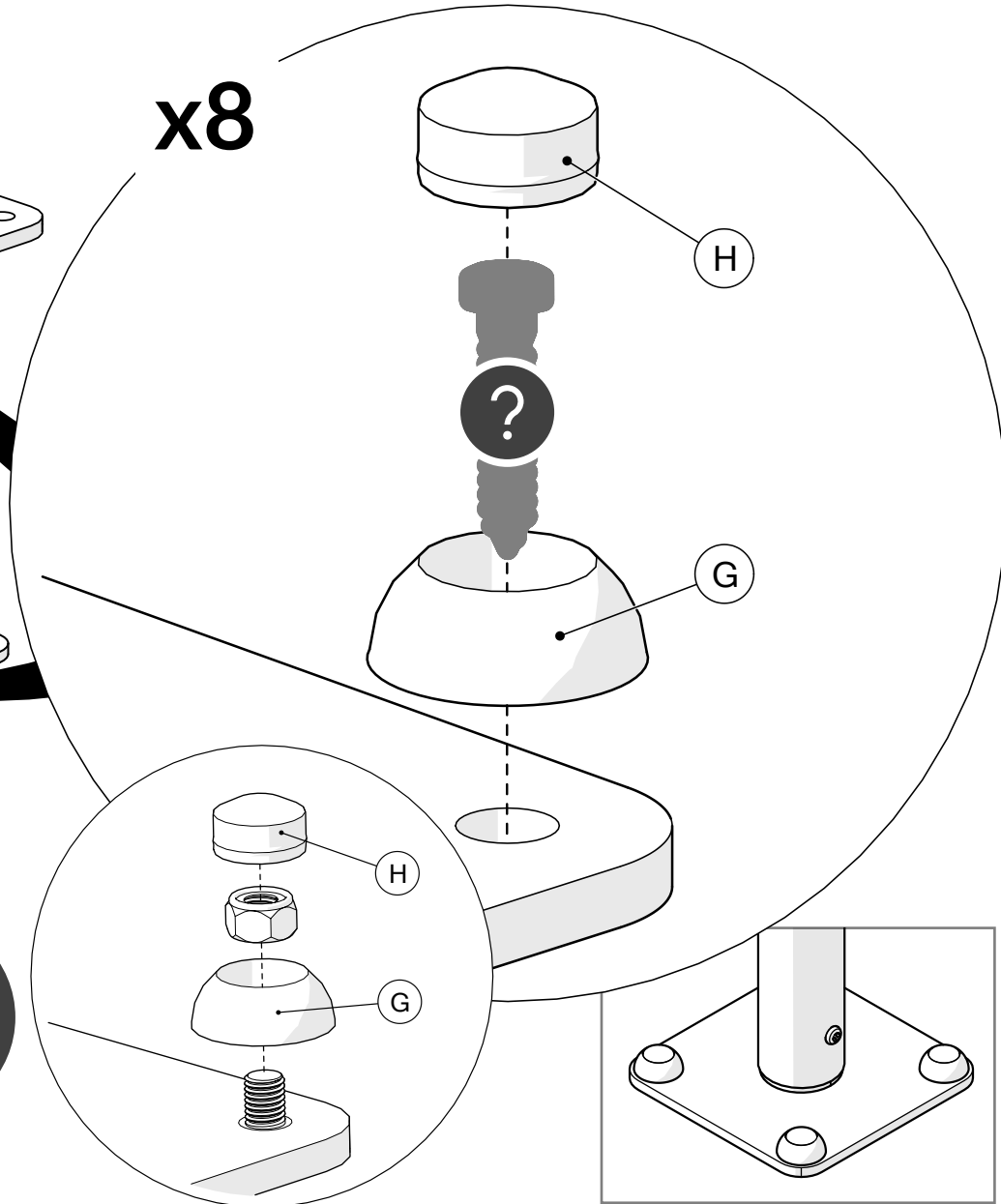

5.



TX30

2		x2
I		x2
J		x4

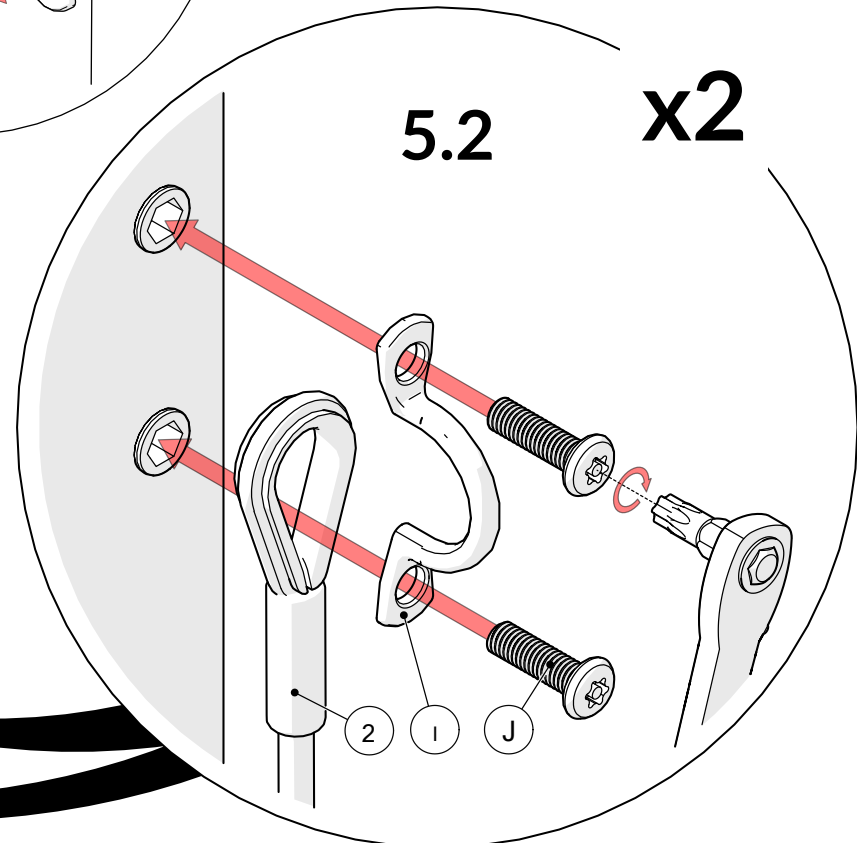
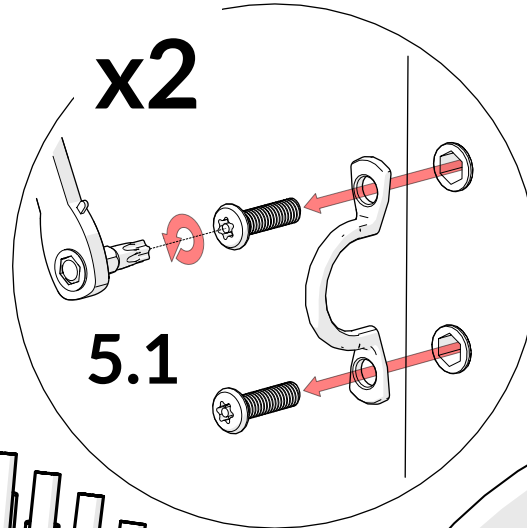
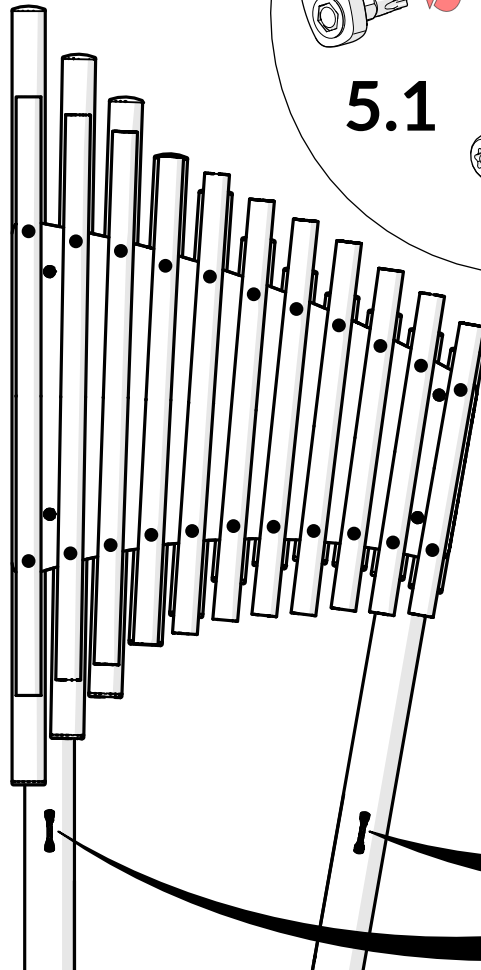

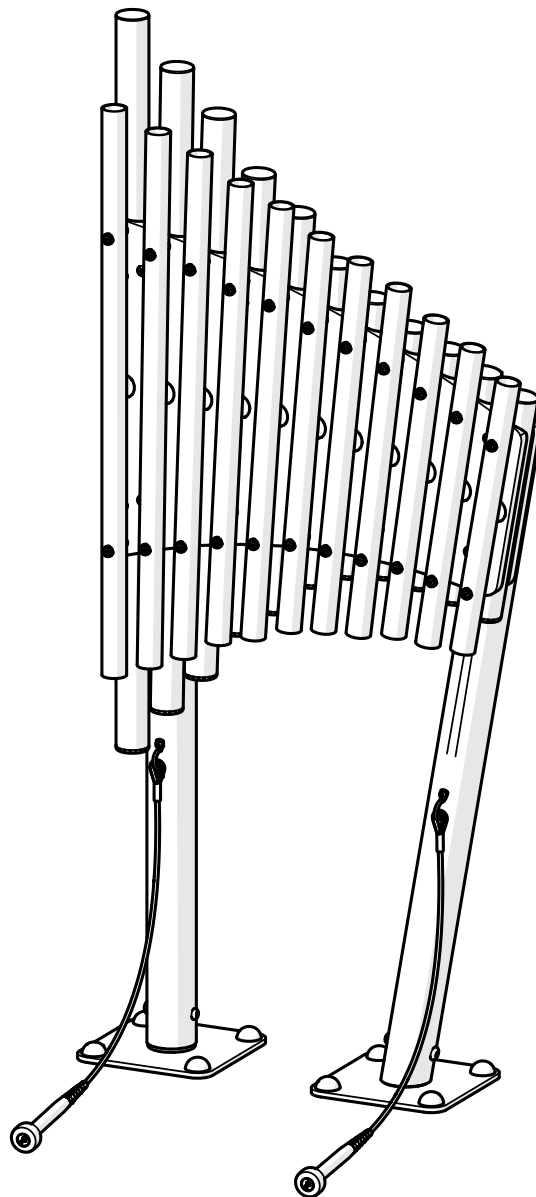

percussionplay.com



info@percussionplay.com



UK
[01730 235 180](tel:01730235180)

USA & CAN
[+1 \(866\) 882 9170](tel:+18668829170)

EUR & ROW
[+44 1730 235 180](tel:+441730235180)