

Part Reference	Description
PP-HFPO-MA-SU	Harmony Flowers Major Posy (Set of 3) (Surface Fix)
PP-HFPO-MI-SU	Harmony Flowers Minor Posy (Set of 3) (Surface Fix)

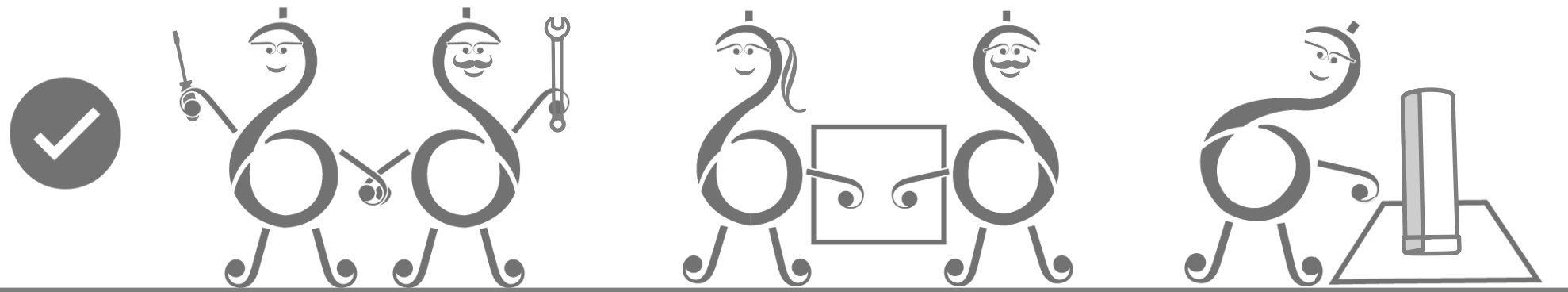

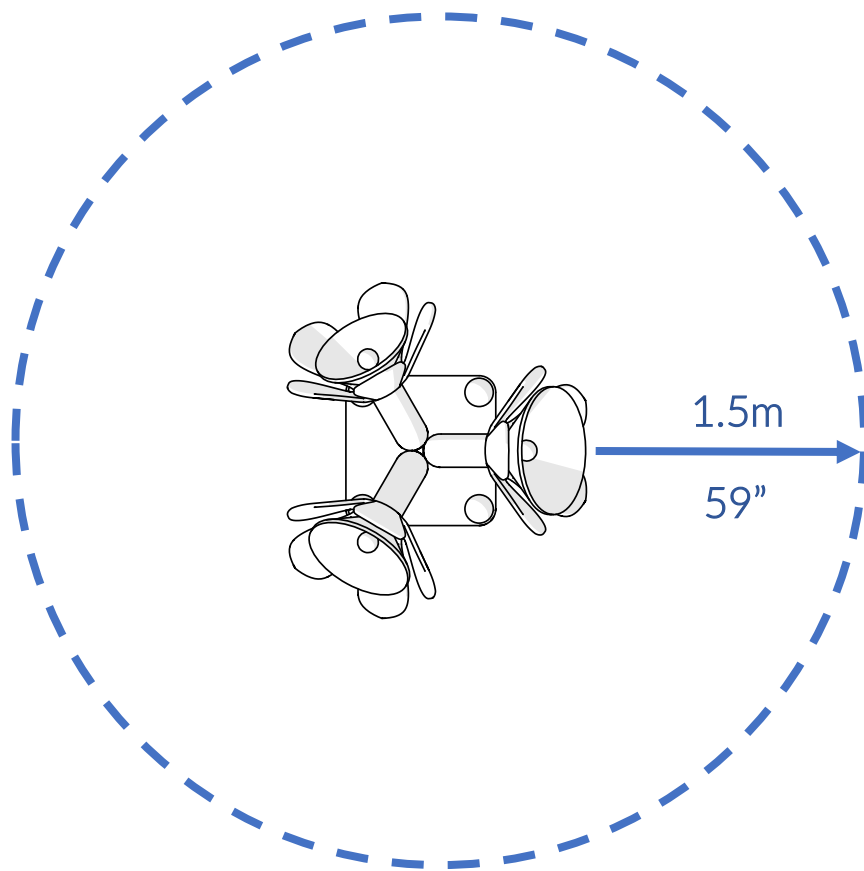



117.5cm  
46"

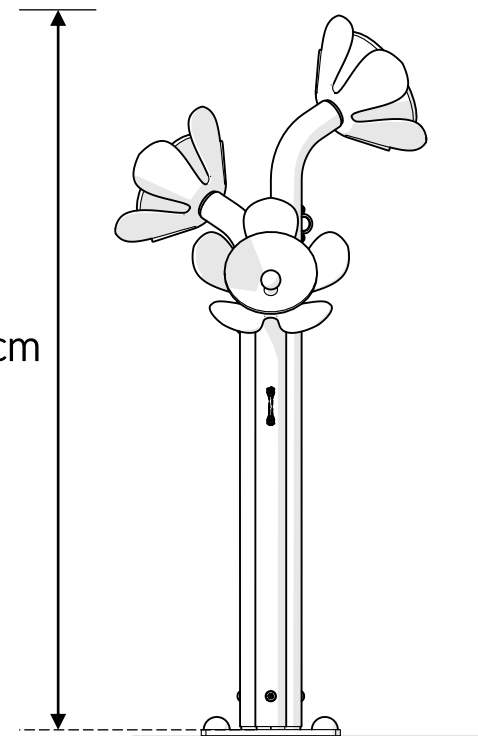

Check Risk Assessment

## Packages

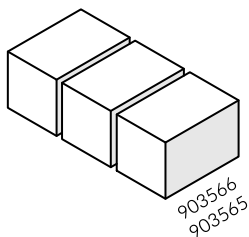

x1

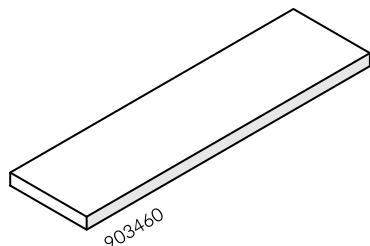

x1

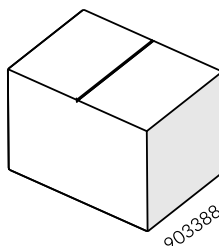

x1

		L	W	H	Weight	Net
x1	903566	42cm / 16.5"	28cm / 11"	28cm / 11"	5kg / 11lbs	
	903565					
x1	903460	126cm / 50"	34cm / 13"	5cm / 2"	12kg / 26.5lbs	
x1	903388	32cm / 12.5"	23cm / 9"	23cm / 9"	6kg / 13lbs	



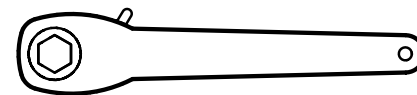

## Tools required (not supplied)

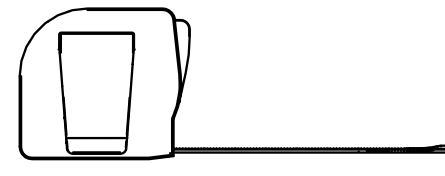

¼" Bit Driver Ratchet





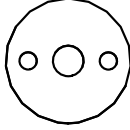
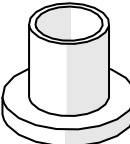
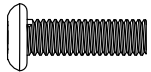
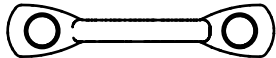
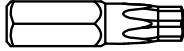
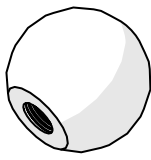

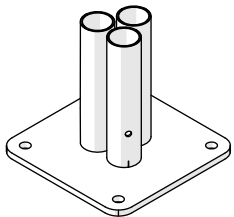
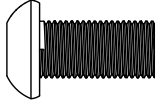
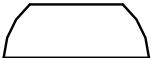

Tape Measure

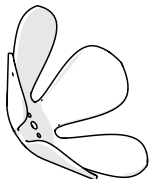
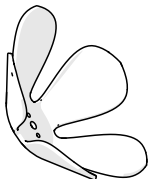
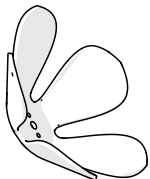

Not to scale		903460			
					
① x1 803274	② x1 803275	③ x1 803276	⑤ x3 900875	⑥ x3 604362	⑦ x3 600592
					
Ⓑ x6 500746	Ⓒ x3 603150	TX30 x1 500473	⑧ x3 603248		

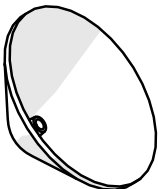

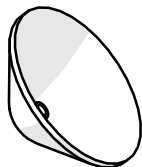

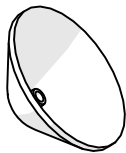

903388	
④ x1 803387	
Ⓐ x3 501203	
Ⓓ x4 601543	
Ⓔ x4 601542	
TX45 x2 500720	

C-Major Posy

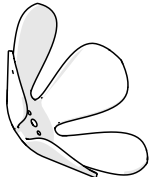
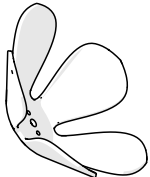
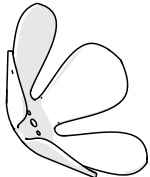
903566		
903559	903563	903561
<p>⑨ x1</p> <p>Purple 603233</p> 	<p>⑪ x1</p> <p>Orange 603233</p> 	<p>⑬ x1</p> <p>Green 603233</p> 
<p>⑩ x1</p> <p> C5</p> <p>Red 603305</p> 	<p>⑫ x1</p> <p> E5</p> <p>Yellow 603305</p> 	<p>⑭ x1</p> <p> G5</p> <p>Blue 603301</p> 

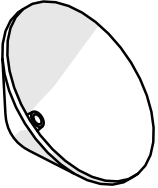
Not to scale

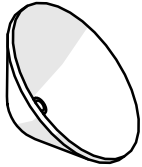
D-Minor Posy

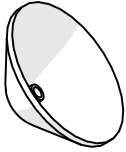
903565		
903562	903560	903564
<p>⑨ x1</p> <p>Red 603233</p> 	<p>⑪ x1</p> <p>Yellow 603233</p> 	<p>⑬ x1</p> <p>Blue 603233</p> 
<p>⑩ x1</p> <p> D5</p> <p>Orange 603304</p> 	<p>⑫ x1</p> <p> F5</p> <p>Green 603302</p> 	<p>⑭ x1</p> <p> A5</p> <p>Indigo 603300</p> 

**1.**

**1.1**

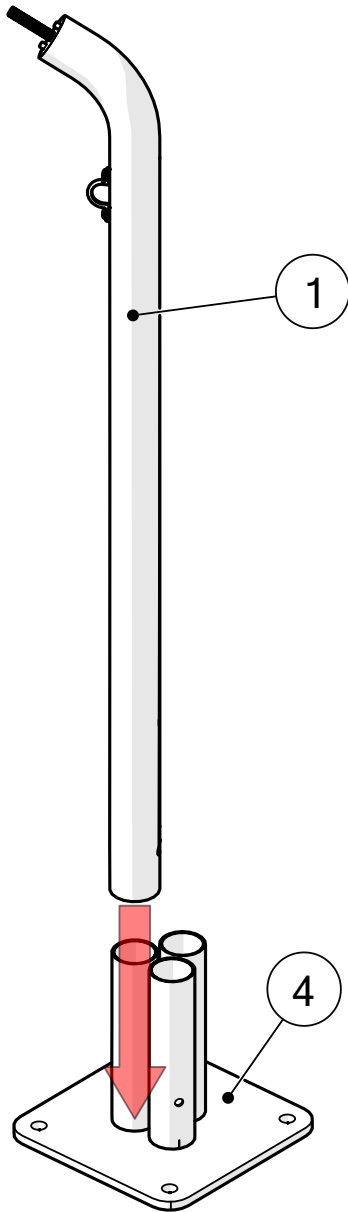

**1.2**

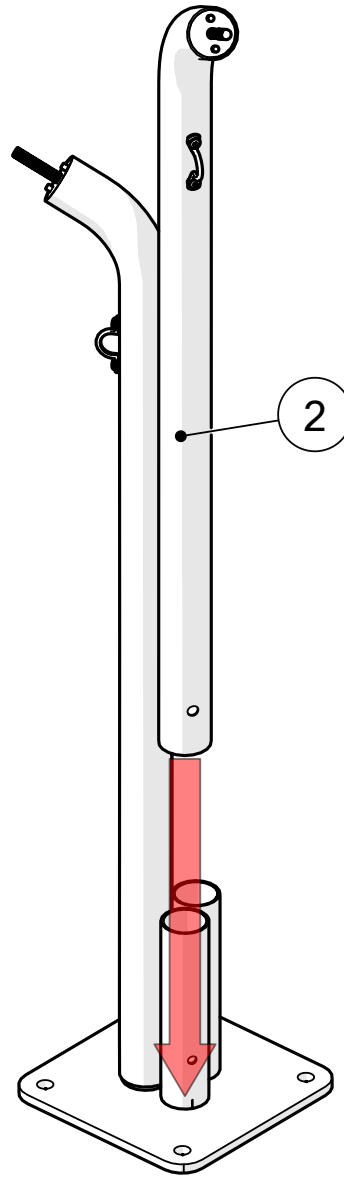

**1.3**

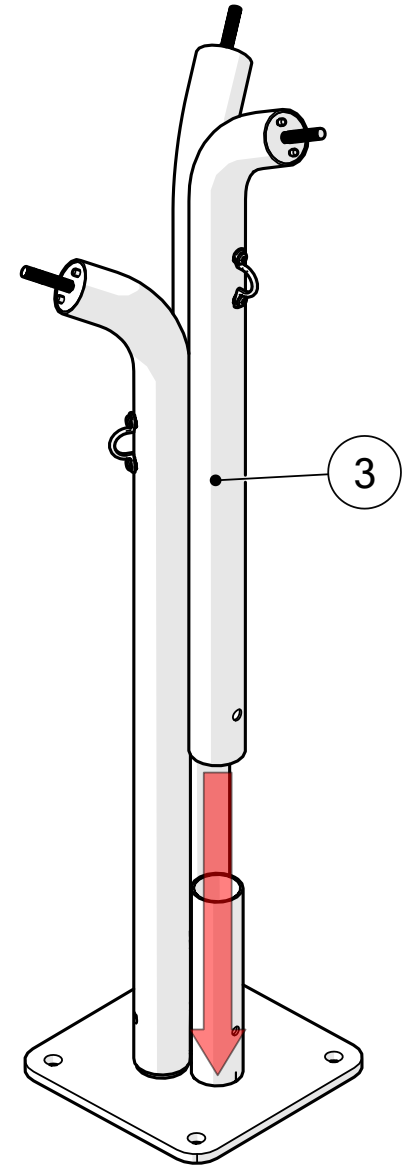

2.

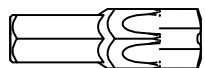
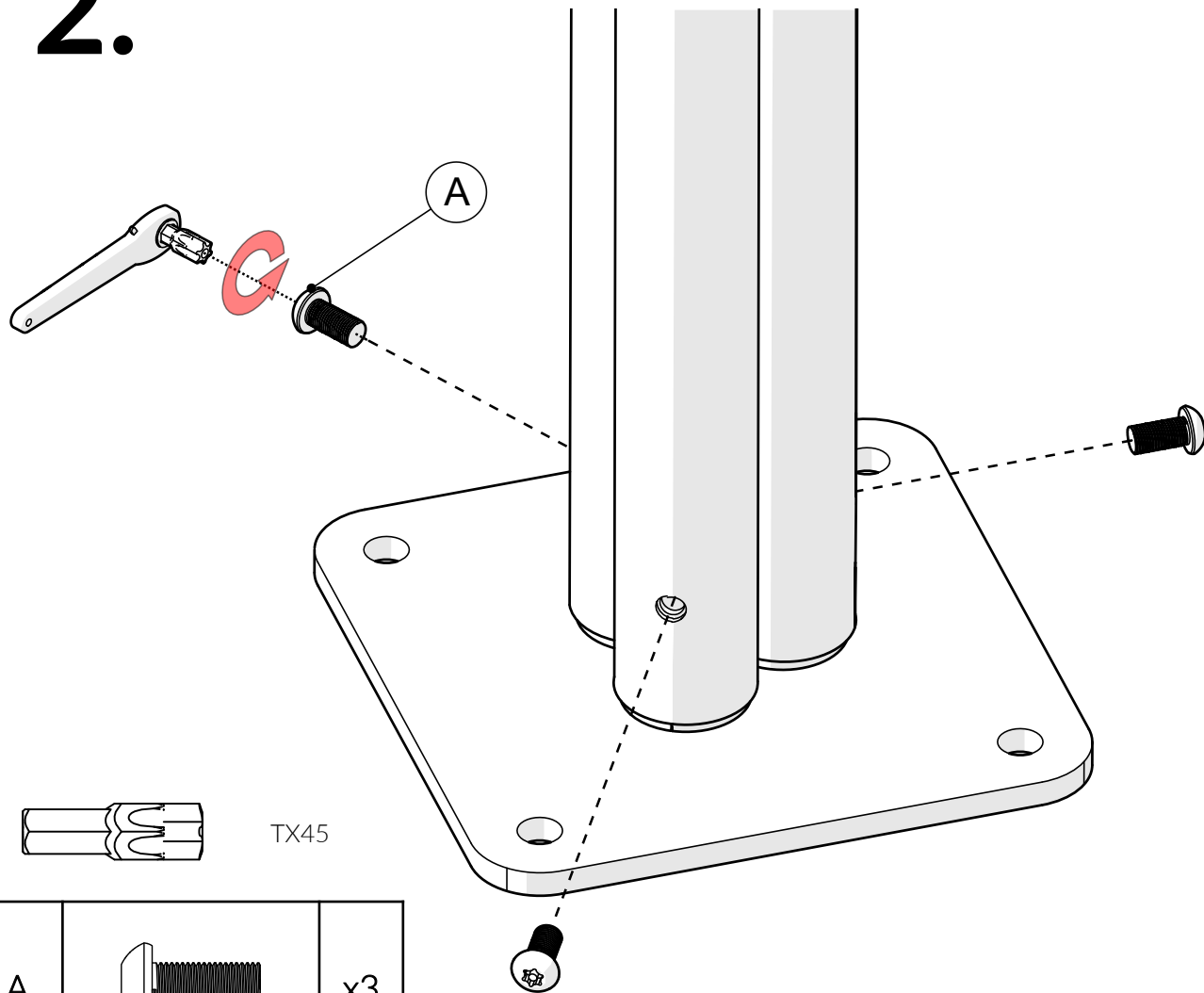

TX45

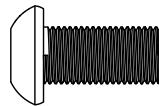
A		x3
---	---	----

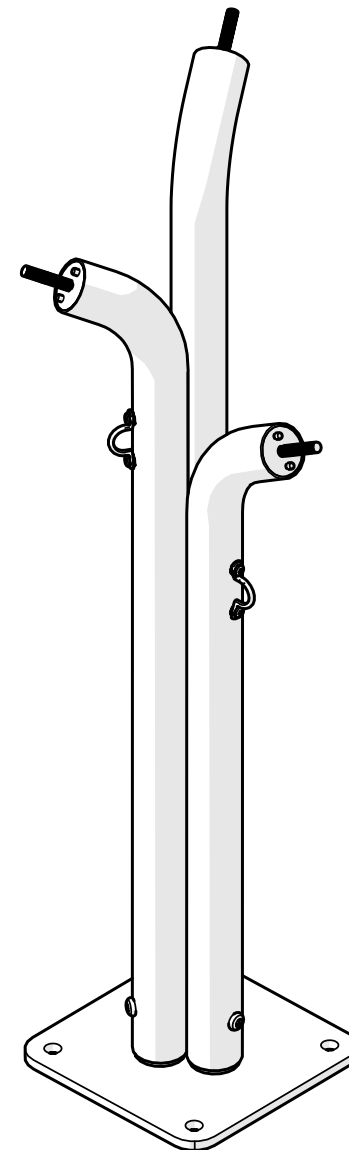





# 3.

Surface fixing should not present a hazard







Refer to your local Health & Safety standards

D		x4
E		x4

Surface

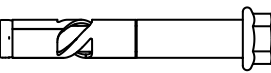
Example fixing

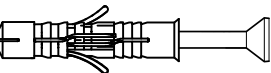
	Wood		x4
	Concrete		x4
	Brick		x4

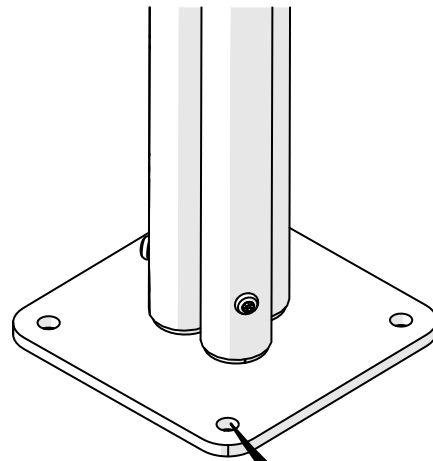

x4

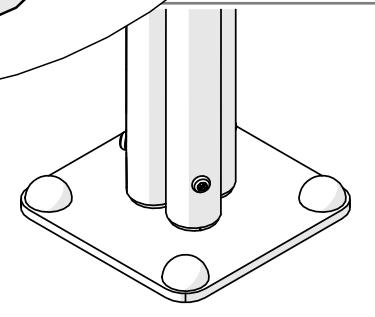
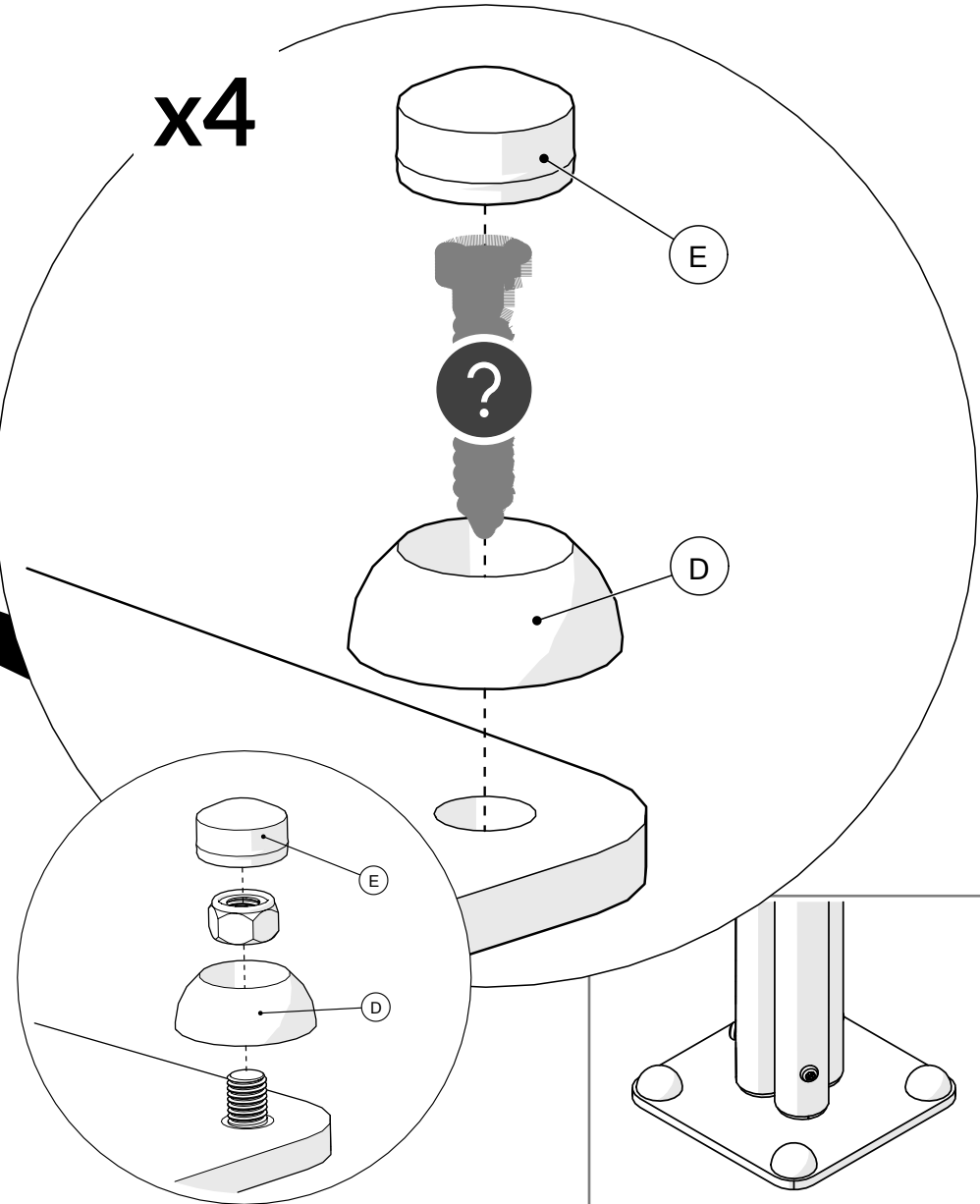

**4. x3**

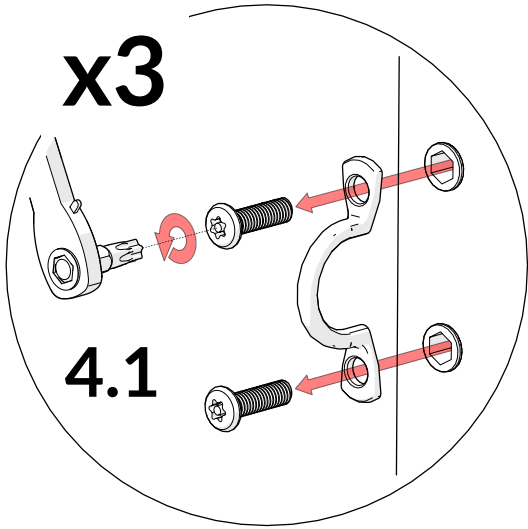

TX30

5		x3
B		x6
C		x3

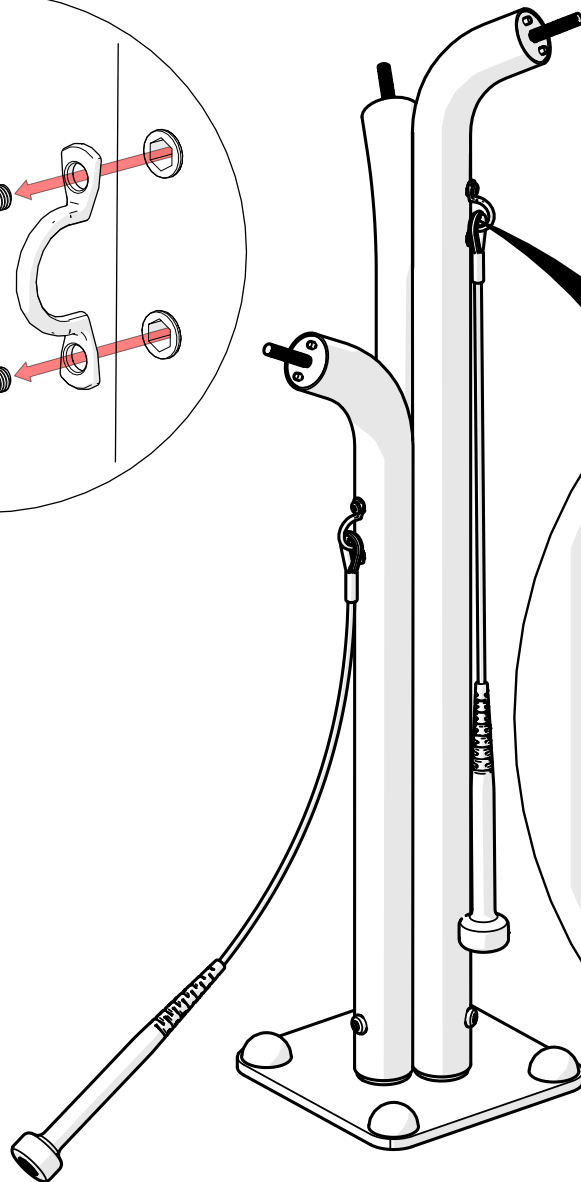

**4.2**

**x3**

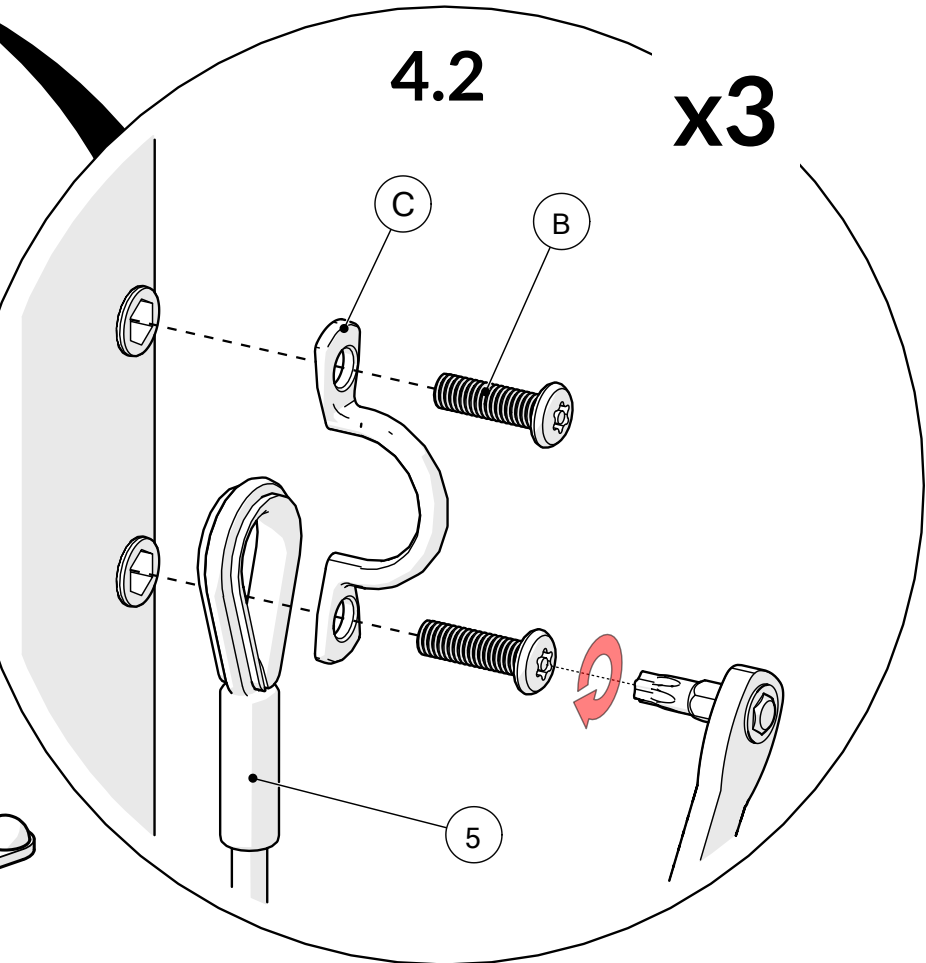

# 5. x3

C-Major Posy

## 5.1

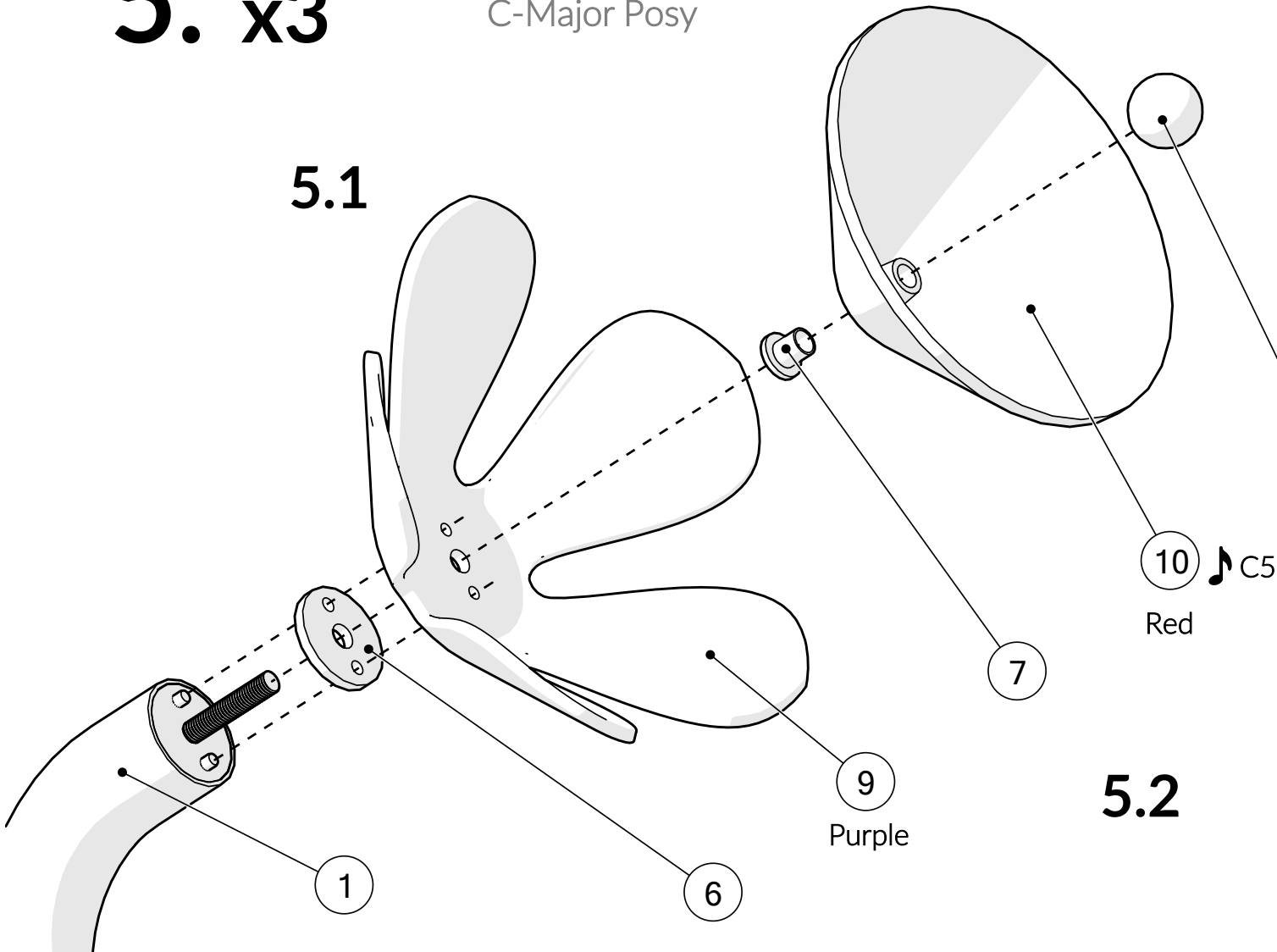

② + ⑪ + ⑫ 🎵 E5  
Orange Yellow

③ + ⑬ + ⑭ 🎵 G5  
Green Blue

## 5.2

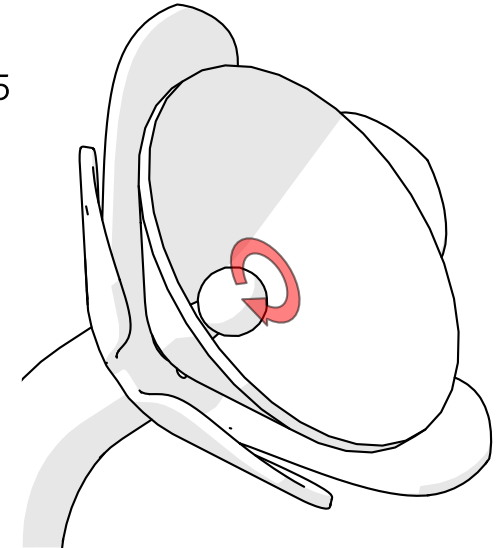

# 5. x3

## D-Minor Posy

### 5.1

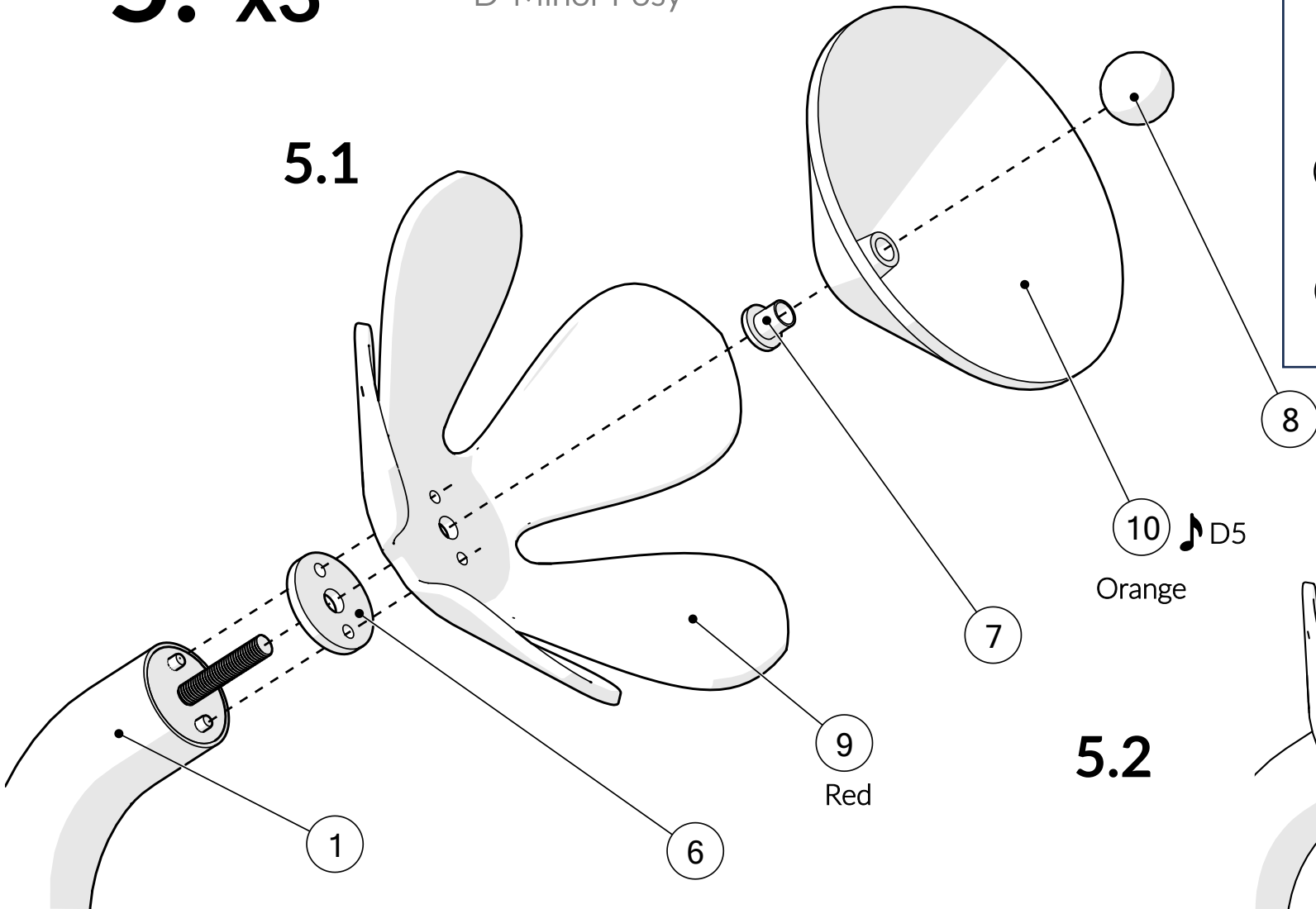

(2) + (11) + (12) 🎵 F5  
 Yellow Green

(3) + (13) + (14) 🎵 A5  
 Blue Indigo

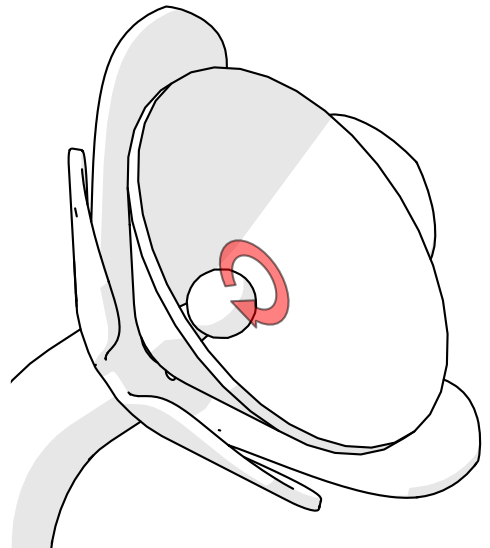

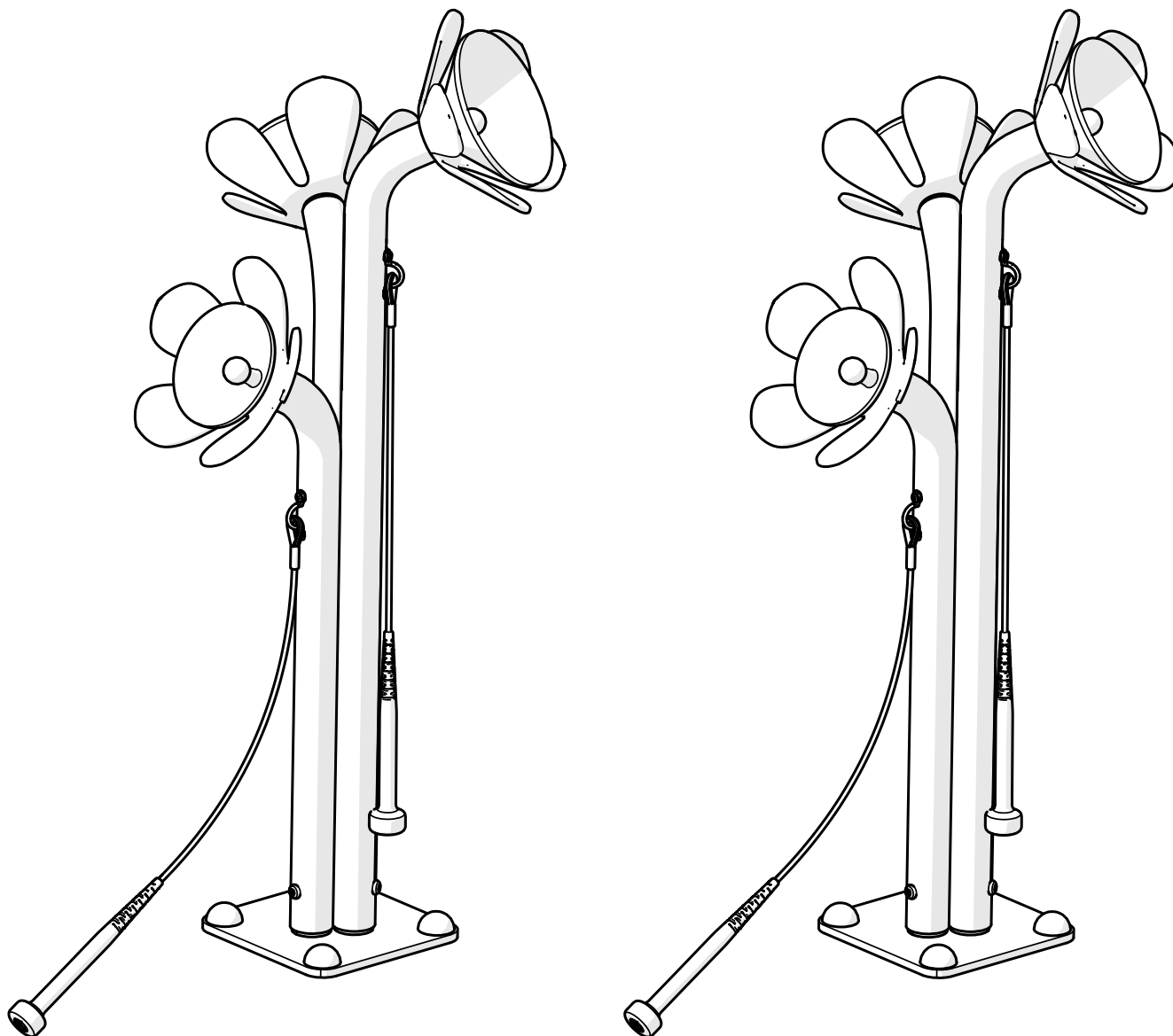

[percussionplay.com](http://percussionplay.com)



[info@percussionplay.com](mailto:info@percussionplay.com)



UK  
[01730 235 180](tel:01730235180)

USA & CAN  
[+1 \(866\) 882 9170](tel:+18668829170)

EUR & ROW  
[+44 1730 235 180](tel:+441730235180)