

Part Reference	Description
PP-FREC-SO-DI-SU	C5-C6 Soprano Diatonic - 8 notes (Surface Fix)

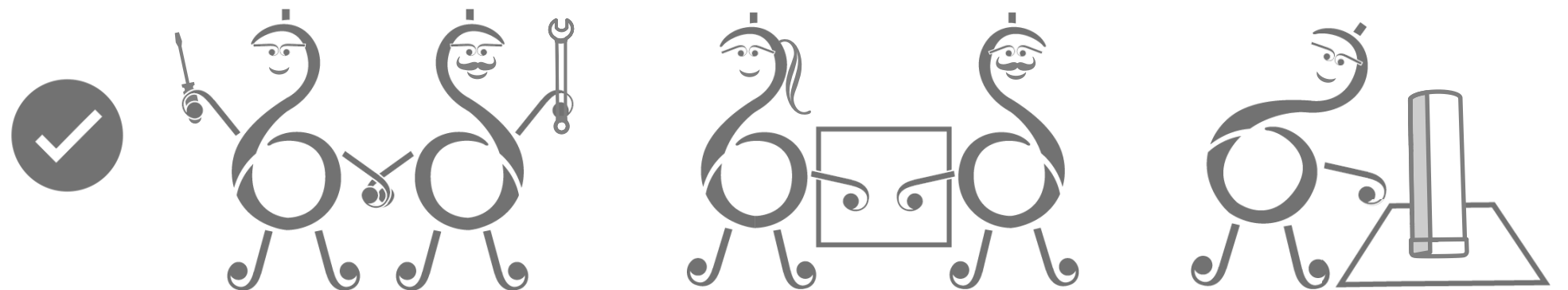

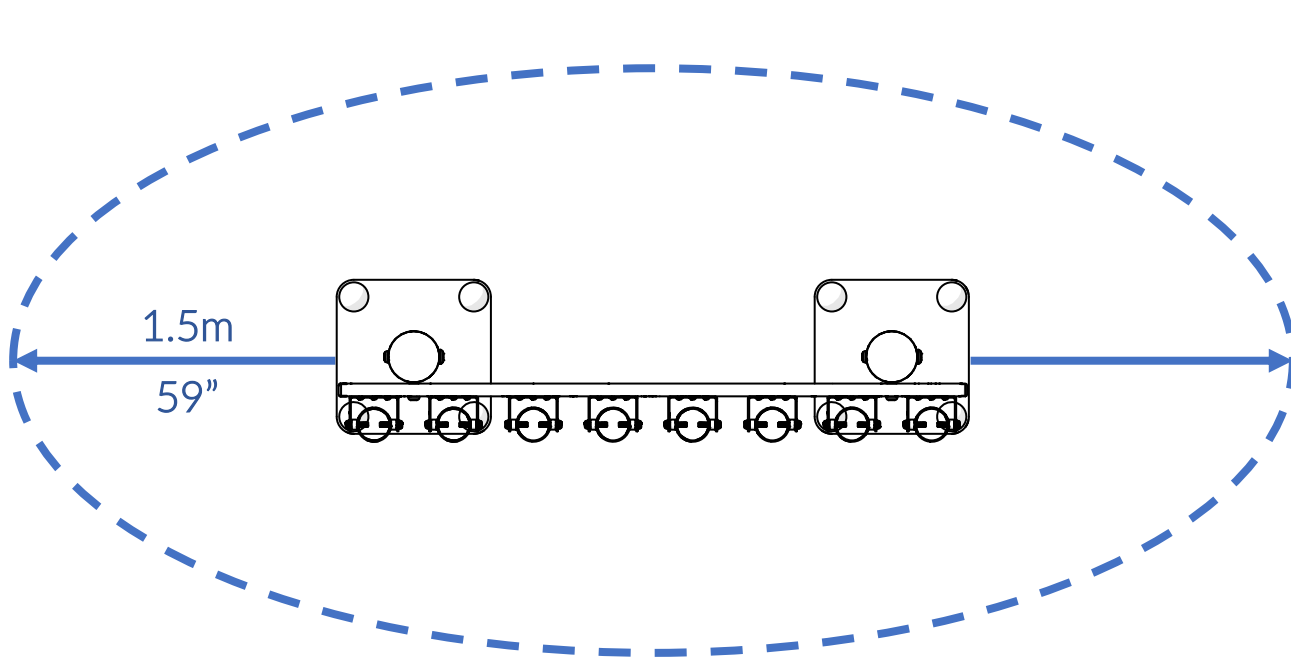



Check Risk Assessment

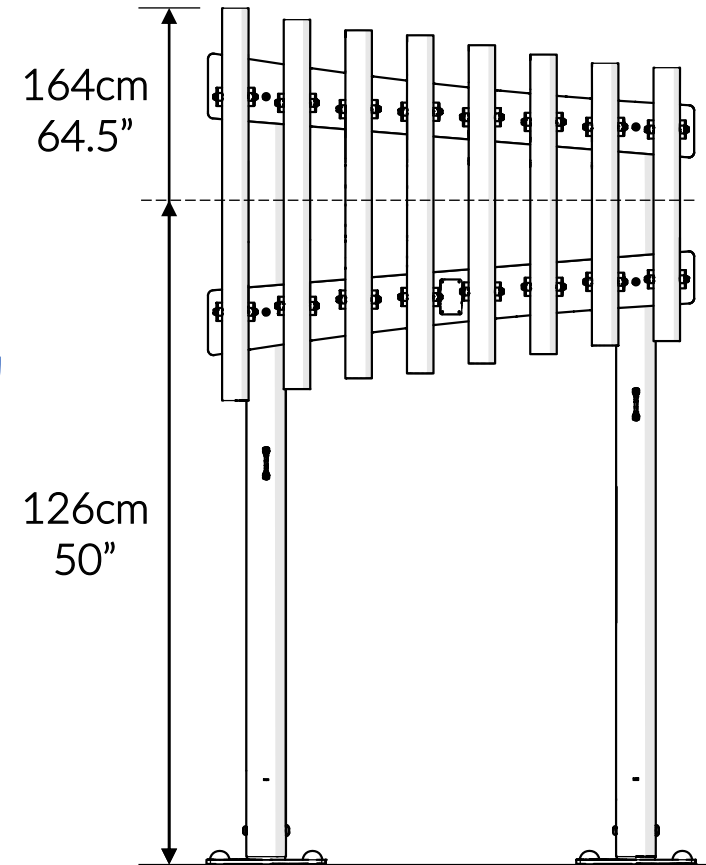

Packages

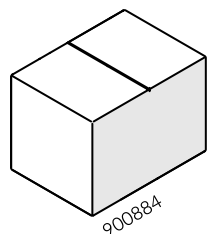

x2

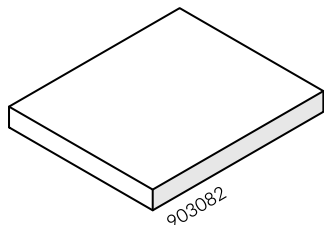

x1

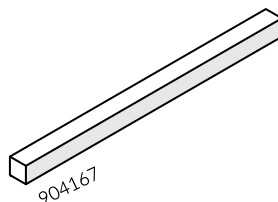

x1

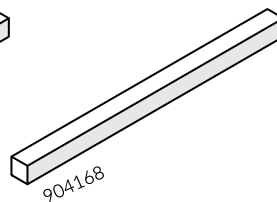

x1

		L	W	H	Weight	Net
x2	900884	23cm / 9"	23cm / 9"	31cm / 12"	6kg / 13lbs	
x1	903082	95cm / 37.5"	80cm / 31.5"	10cm / 4"	16kg / 35lbs	
x1	904167	160cm / 63"	10cm / 4"	10cm / 4"	9kg / 20lbs	
x1	904168	160cm / 63"	10cm / 4"	10cm / 4"	9kg / 20lbs	

Tools required (not supplied)

¼" Bit Driver Ratchet



¼" hex adapter

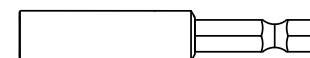



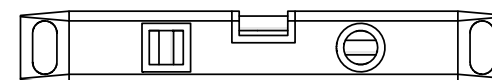



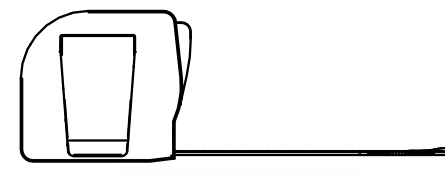

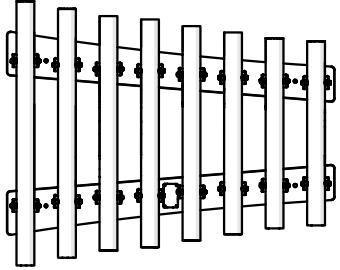
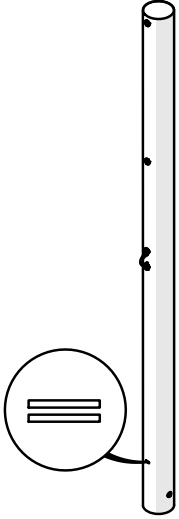
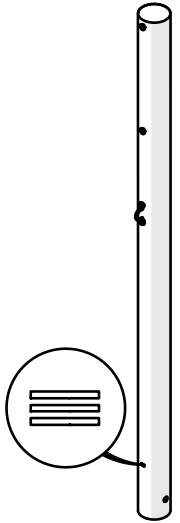
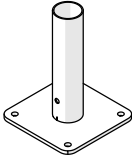
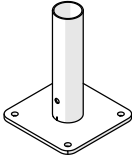



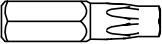
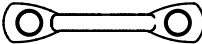
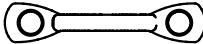

Spirit level

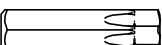
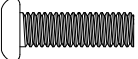
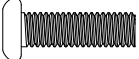

Tape Measure

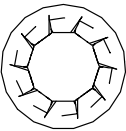

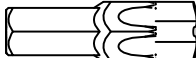
903082		904167	904168	900884	x2
					
 x1		 x1	 x1	 x1 800878	
 x2 900837	TX30 x1 500473 	 x1 603150	 x1 603150	 x1 500667	
	TX40 x1 500474 	 x2 500746	 x2 500746	 x1 500613	
	 x4 502452	 x4 601543		 x4 601543	
	 x4 500456	 x4 601542		 x4 601542	
				TX45 x2 500720 	
Not to scale					

1.

1.1

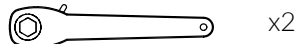
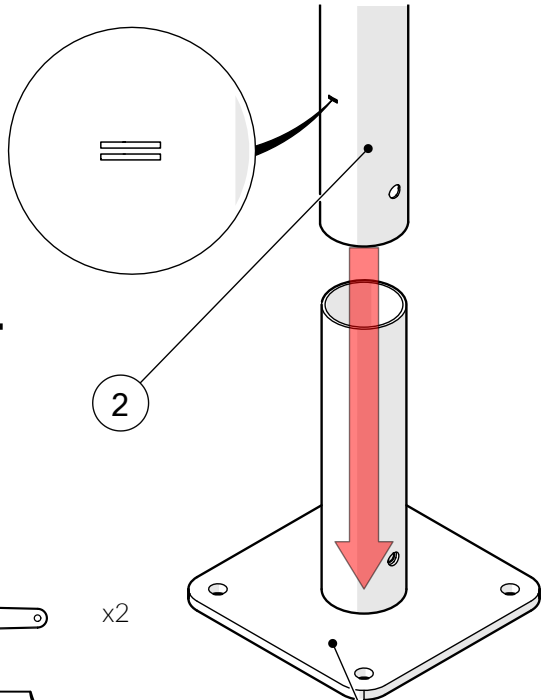

x2

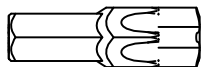

x2 TX45

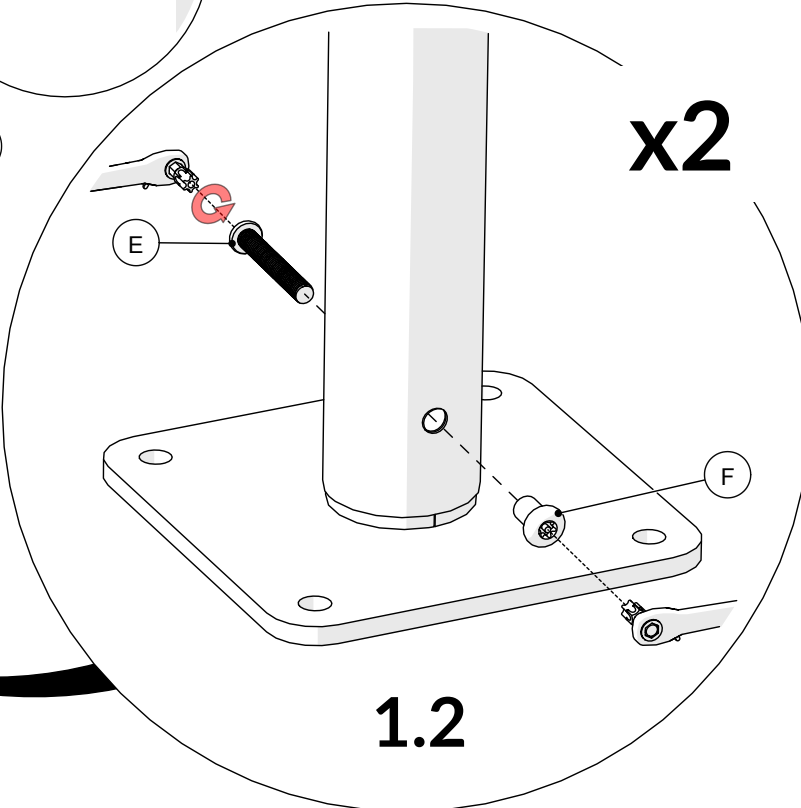
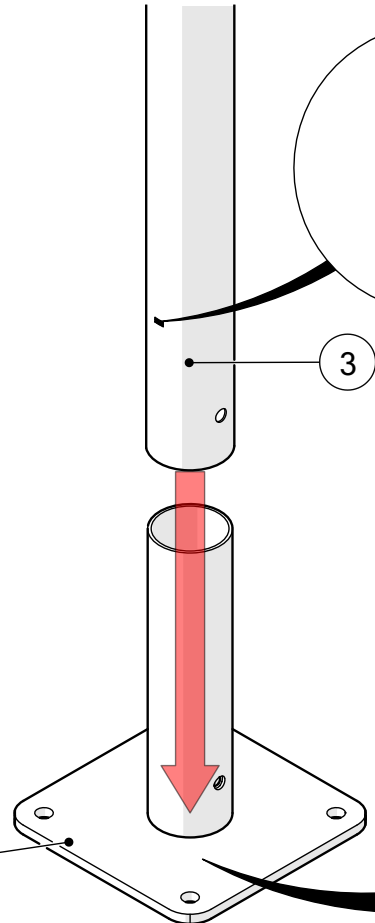

1.2

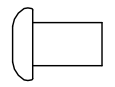
E		x2
F		x2

2.

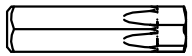
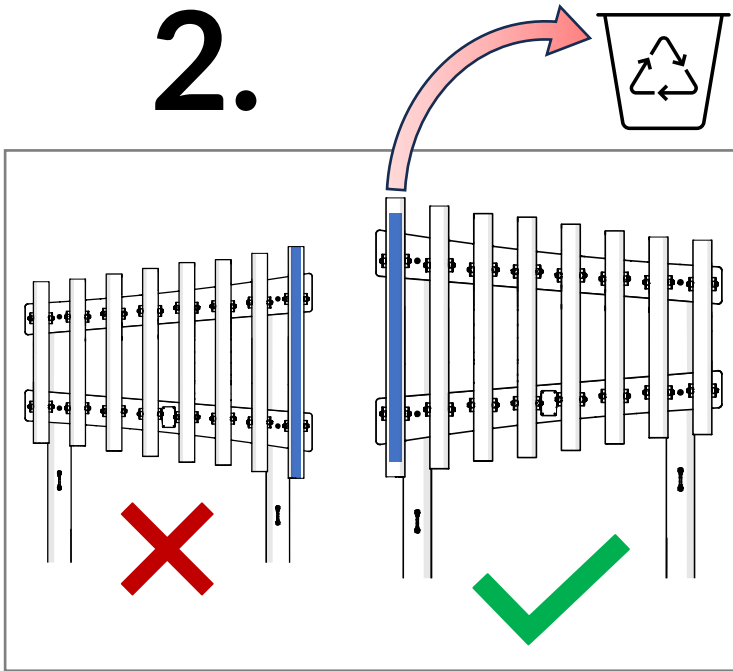

TX40

A		x4
B		x4

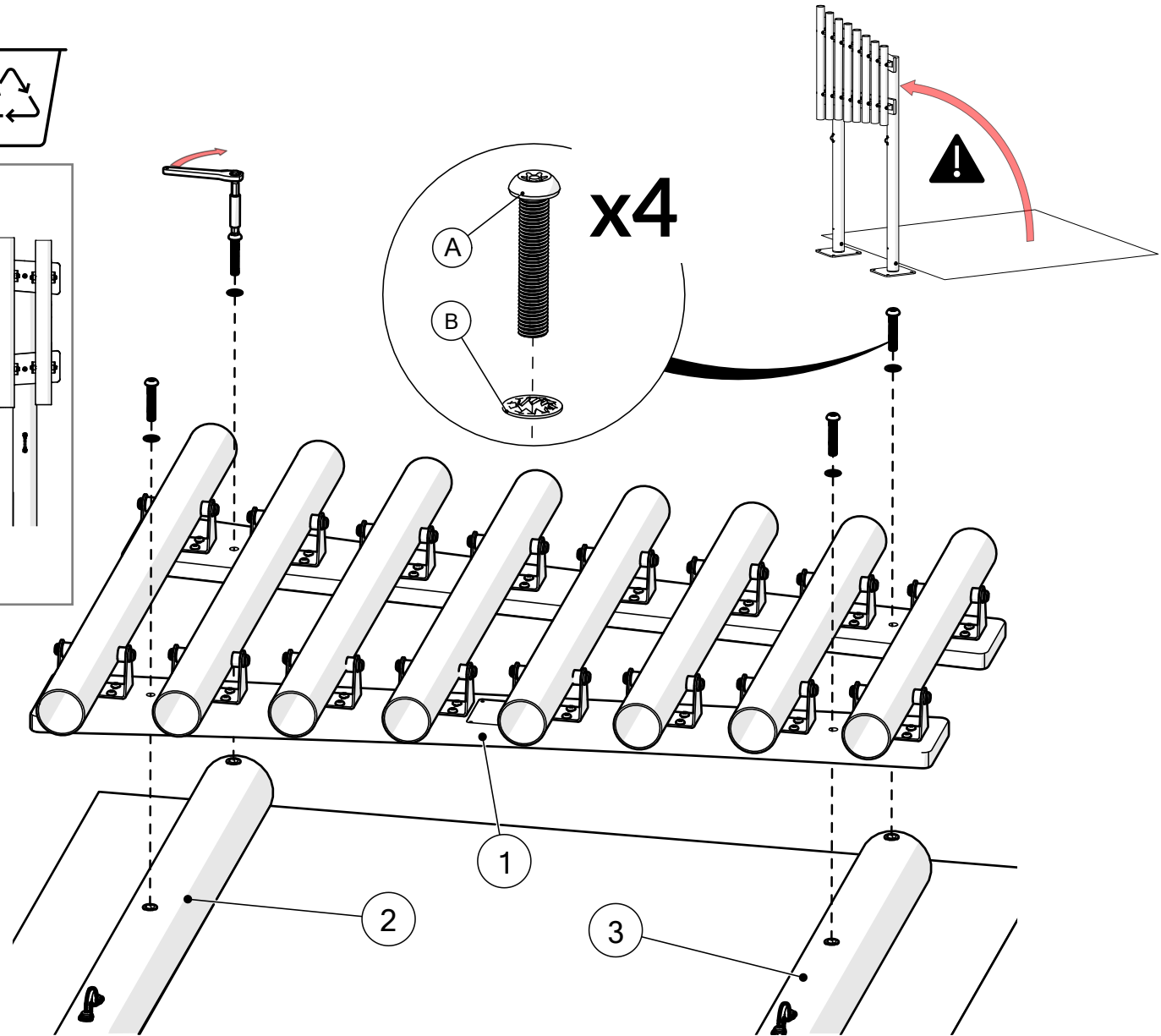

3. x2

Surface fixing should not present a hazard



Refer to your local Health & Safety standards

G		x8
H		x8

Surface

Example fixing

	Wood		x8
	Concrete		x8
	Brick		x8

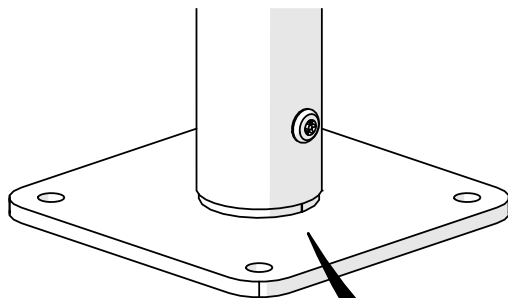

x8

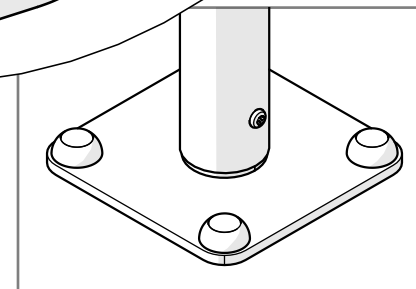
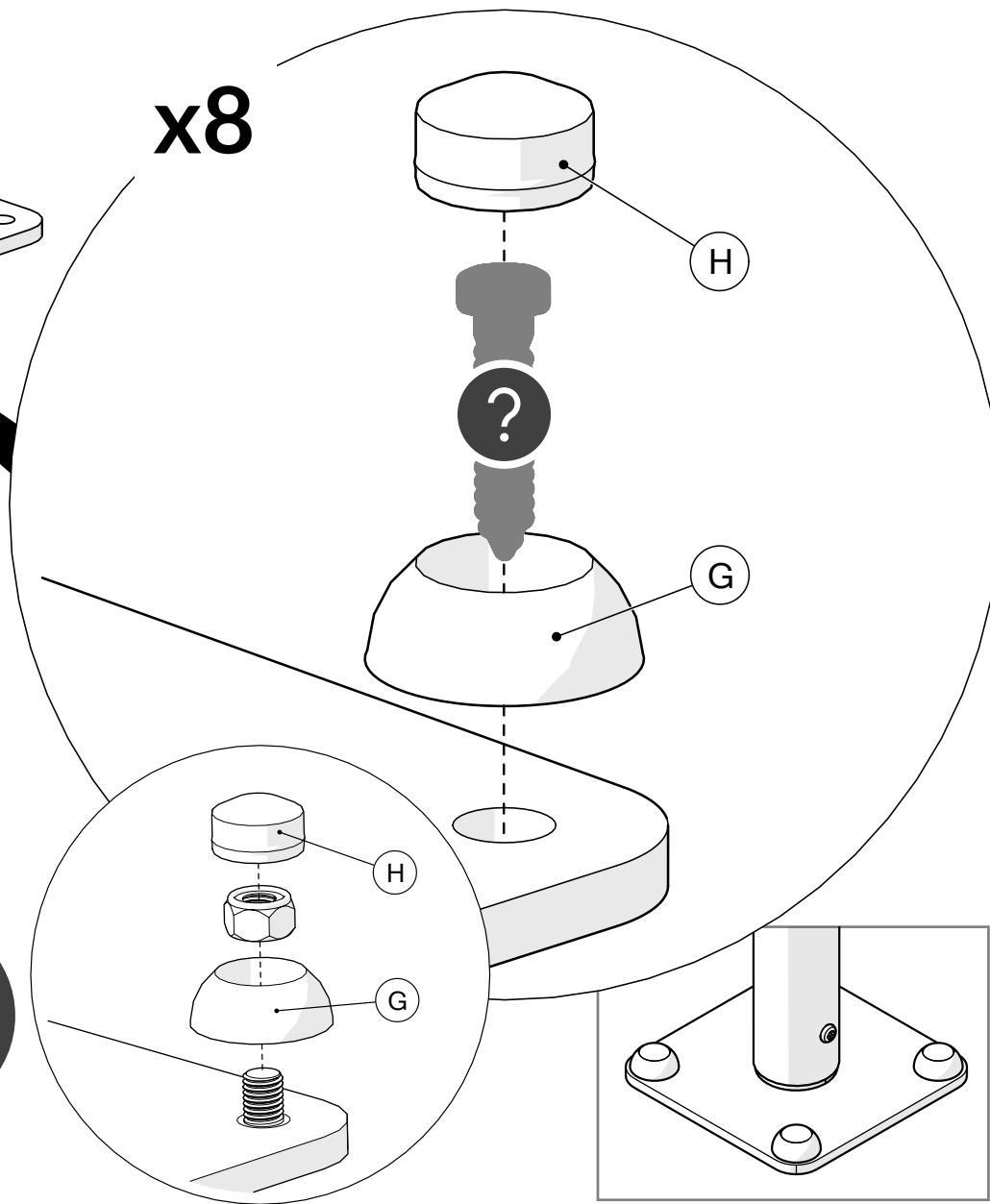

4.

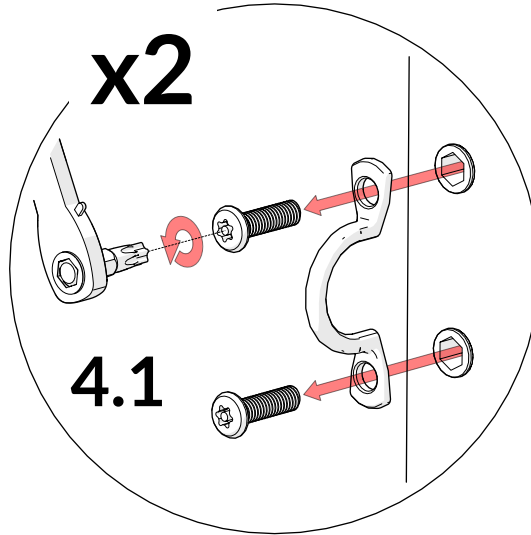

TX30

4		x2
C		x2
D		x4

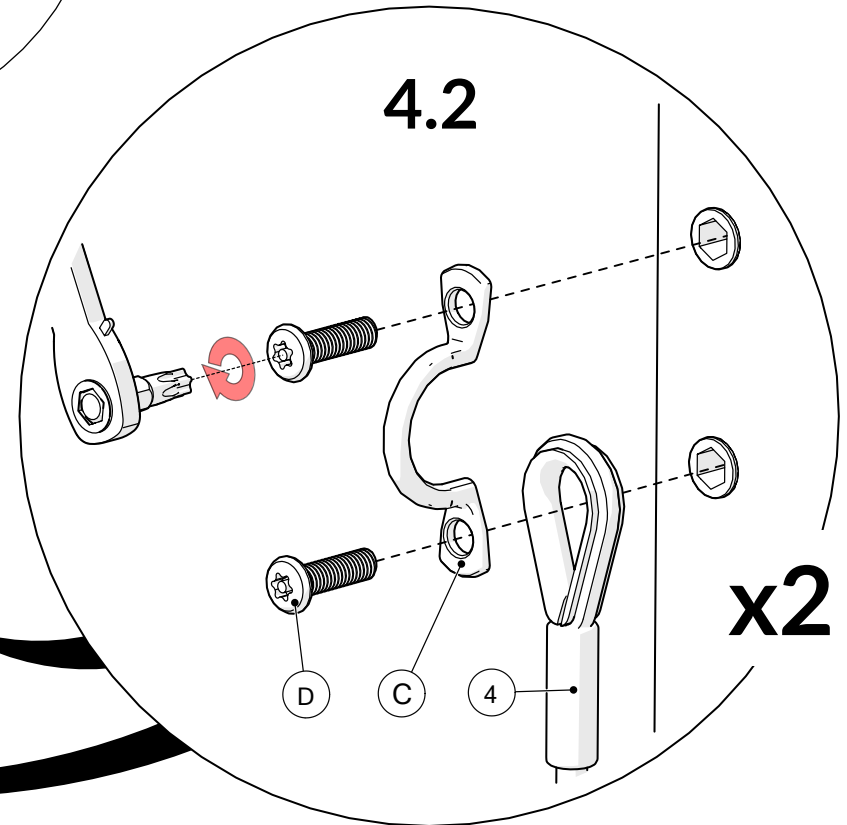
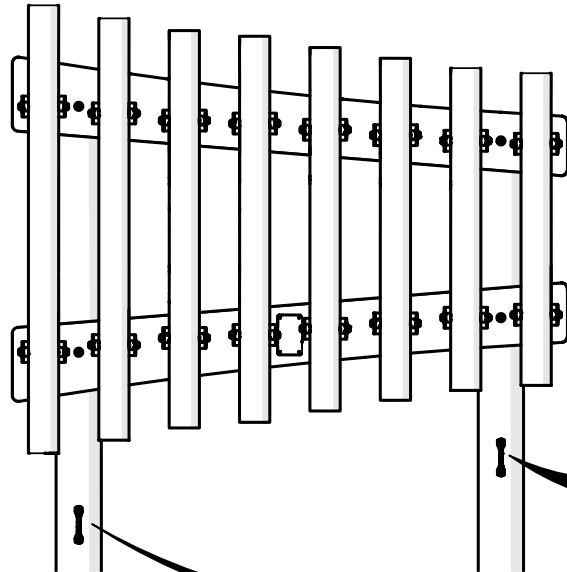

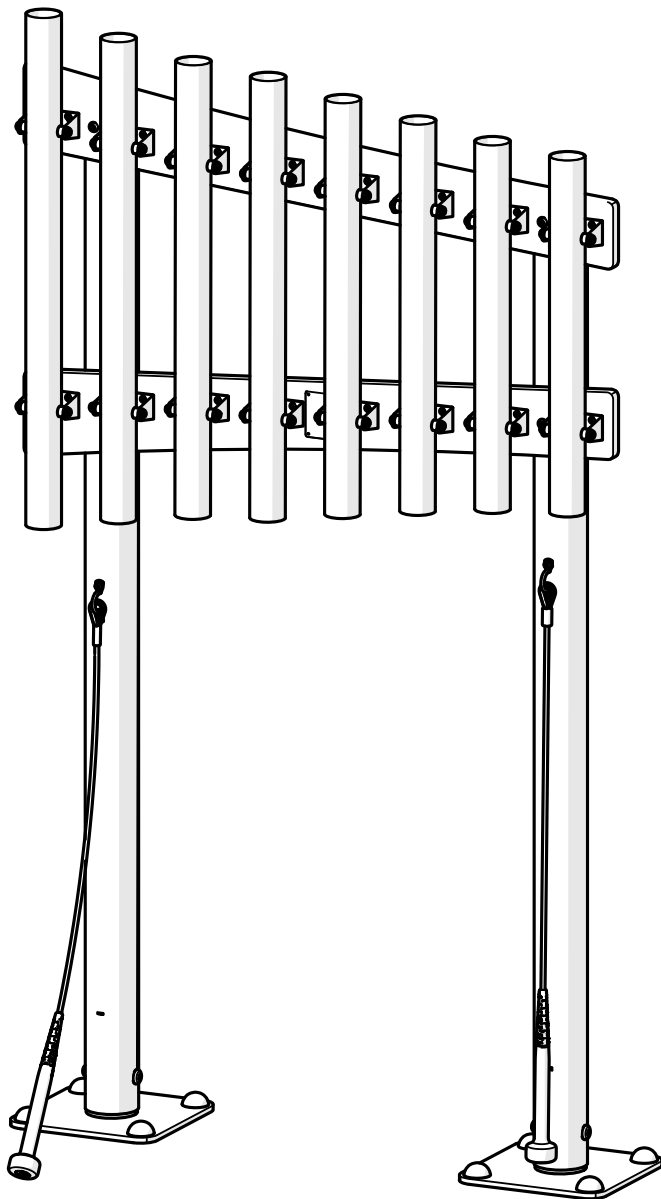

percussionplay.com



info@percussionplay.com



UK
[01730 235 180](tel:01730235180)

USA & CAN
[+1 \(866\) 882 9170](tel:+18668829170)

EUR & ROW
[+44 1730 235 180](tel:+441730235180)