

Part Reference	Description
PP-FREC-SY-DI-WA	C3-C6 Symphony Diatonic - 22 notes (Wall Fix)

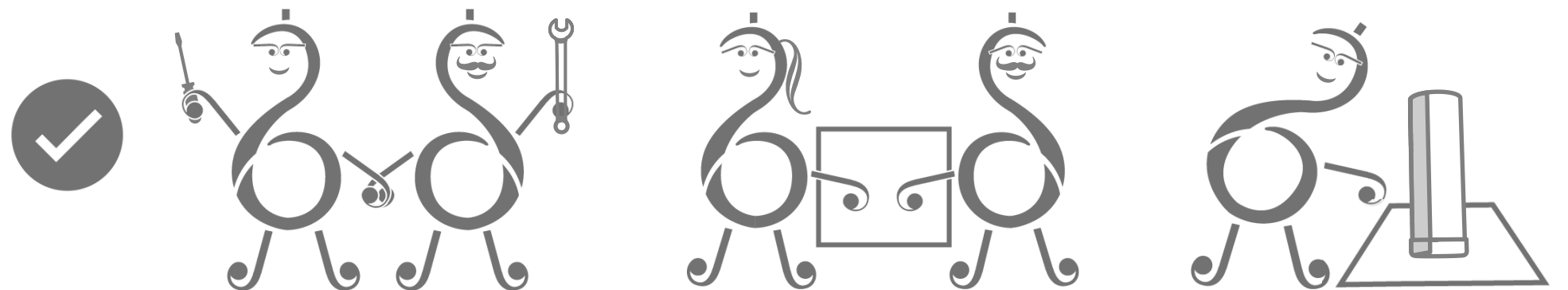

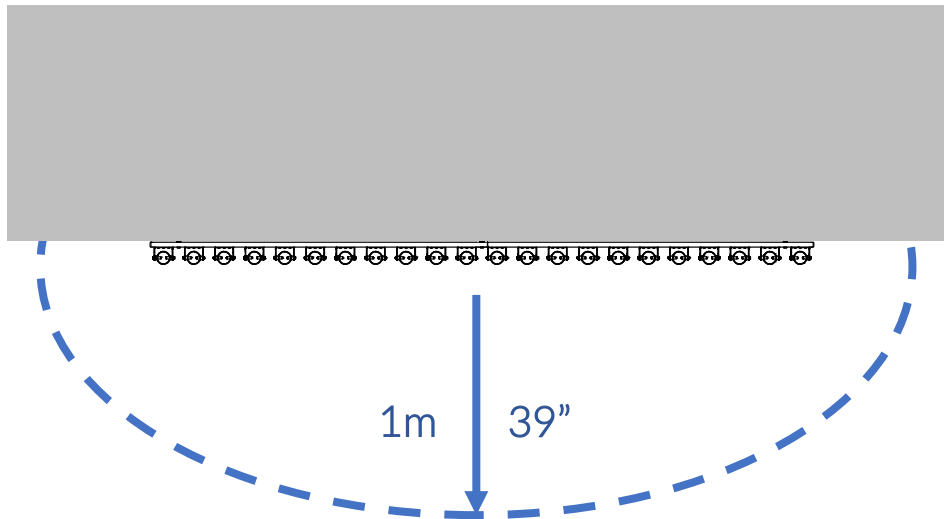

Check Risk Assessment



Confirm
height with
client

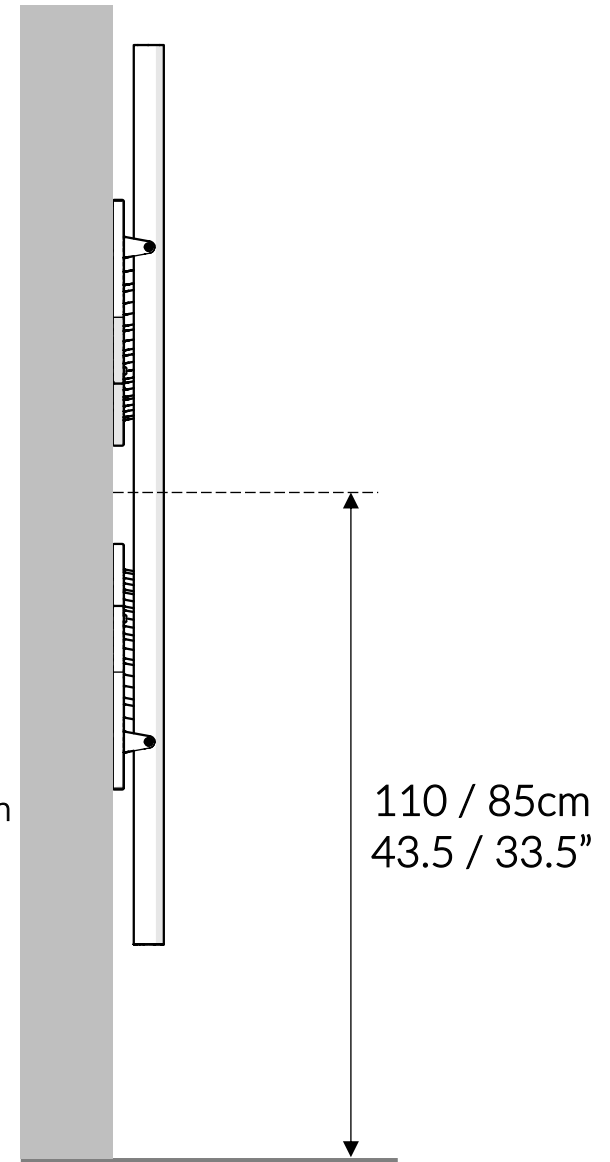

Packages

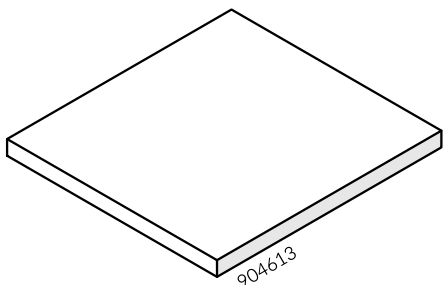

x1

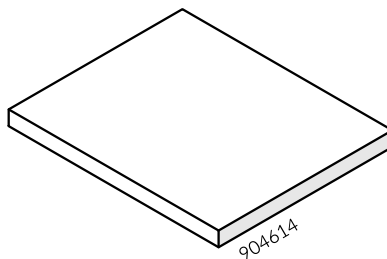

x1

		L	W	H	Weight	Net
x1	904613	150cm / 59"	145cm / 57"	10cm / 4"	21kg / 46lbs	
x1	904614	120cm / 47"	145cm / 57"	10cm / 4"	21kg / 46lbs	

Tools required (not supplied)

¼" Bit Driver Ratchet

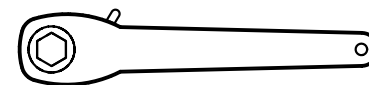

Spirit level

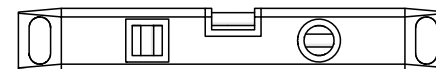

Tape Measure

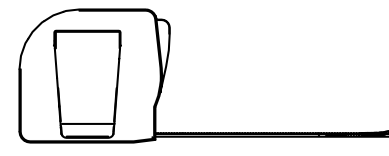

904613

① x1

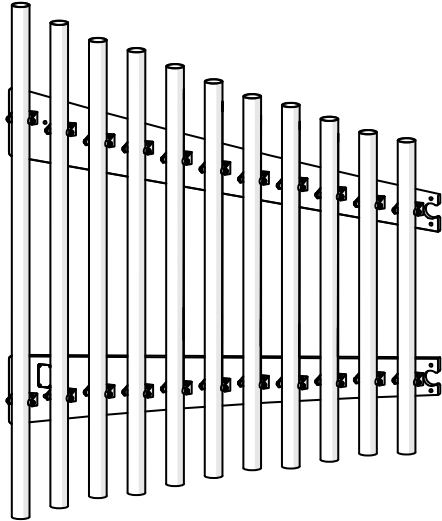

904614

Not to scale

② x1

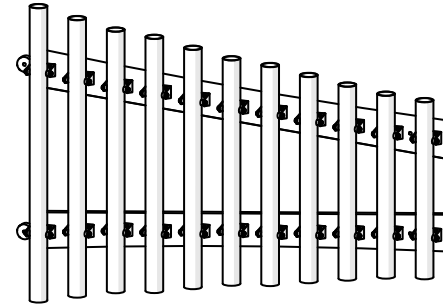

Ⓐ x2
603150

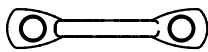

TX25 x1
500472

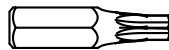

③ x1
900837

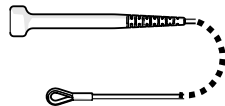

Ⓑ x4
500448



④ x2
900832

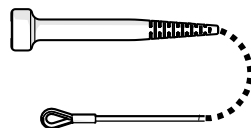

Ⓐ x1
603150

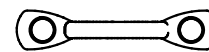

③ x1
900837

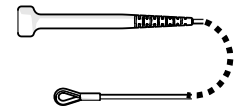

Ⓑ x2
500448

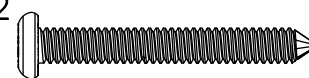

④ x2
900832

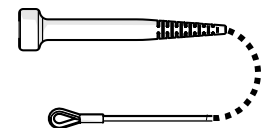



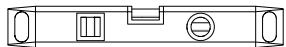
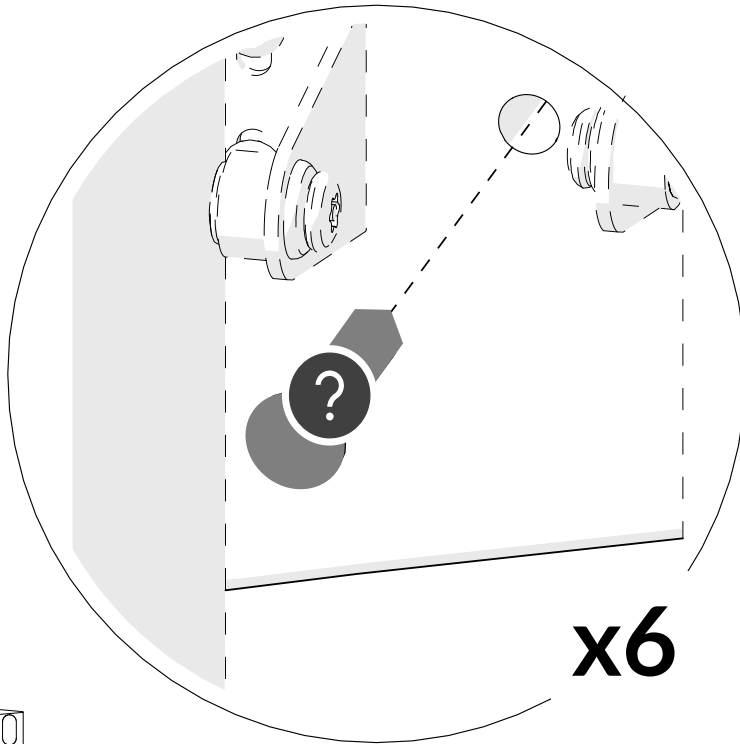

1.

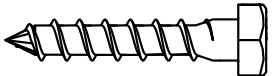

Wall

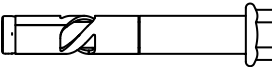
Example fixing

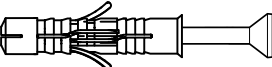
	Wood		x6
	Concrete		x6
	Brick		x6

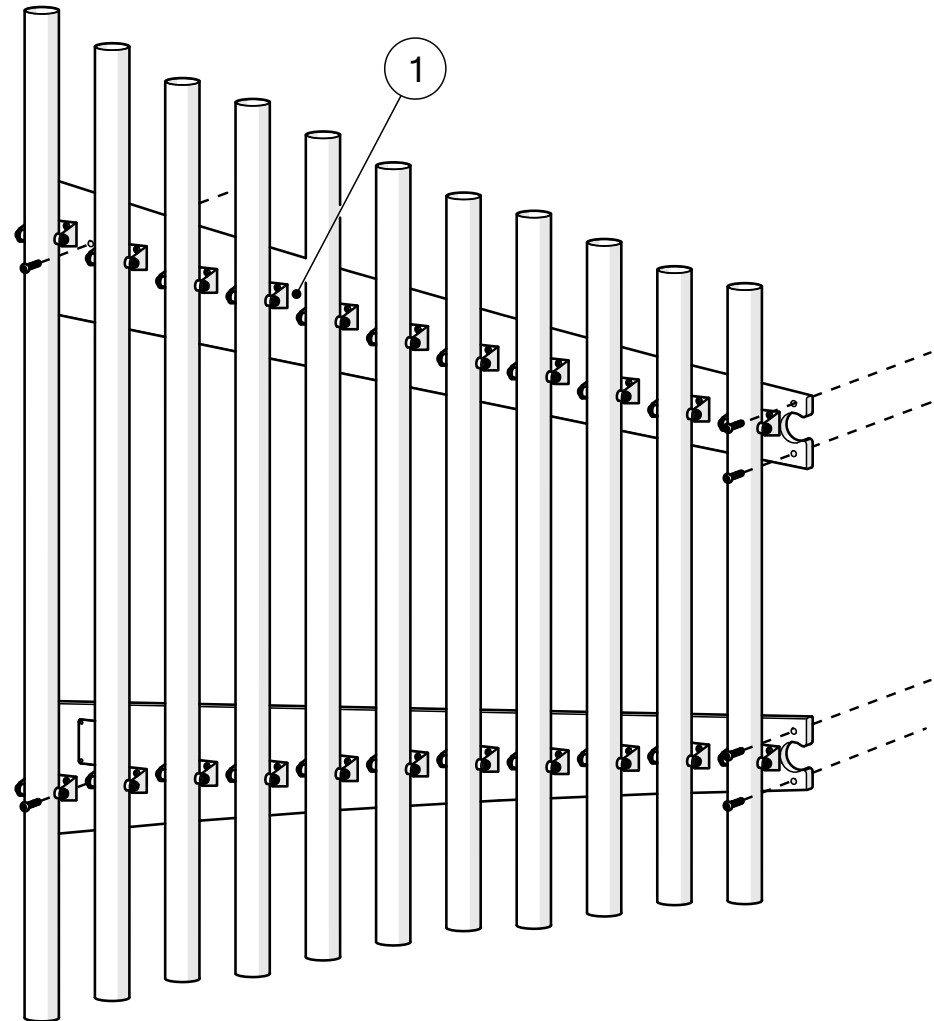



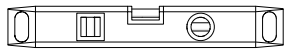
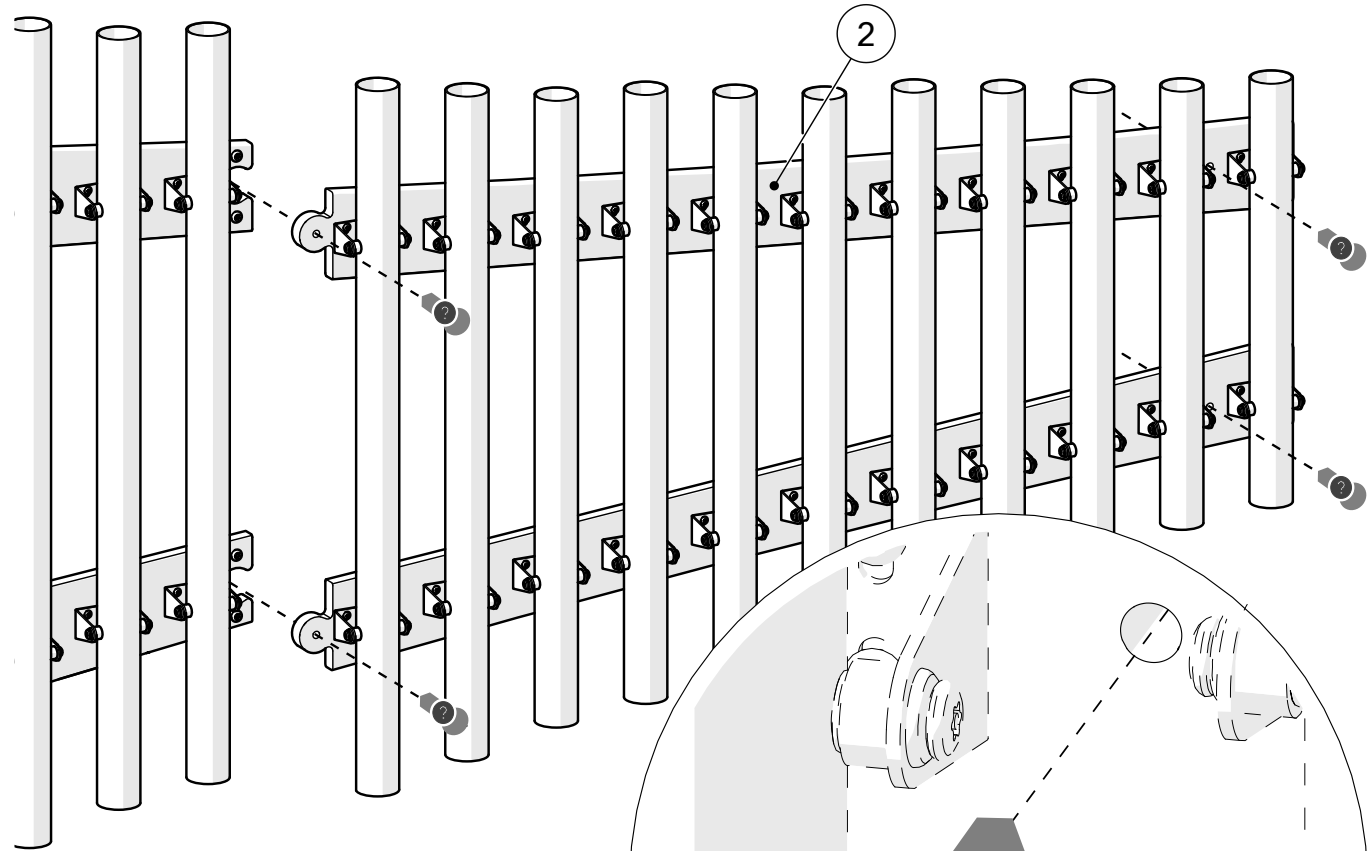

2.

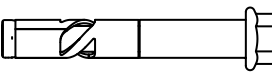

Wall

Example fixing

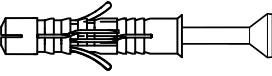
	Wood		x4
	Concrete		x4
	Brick		x4

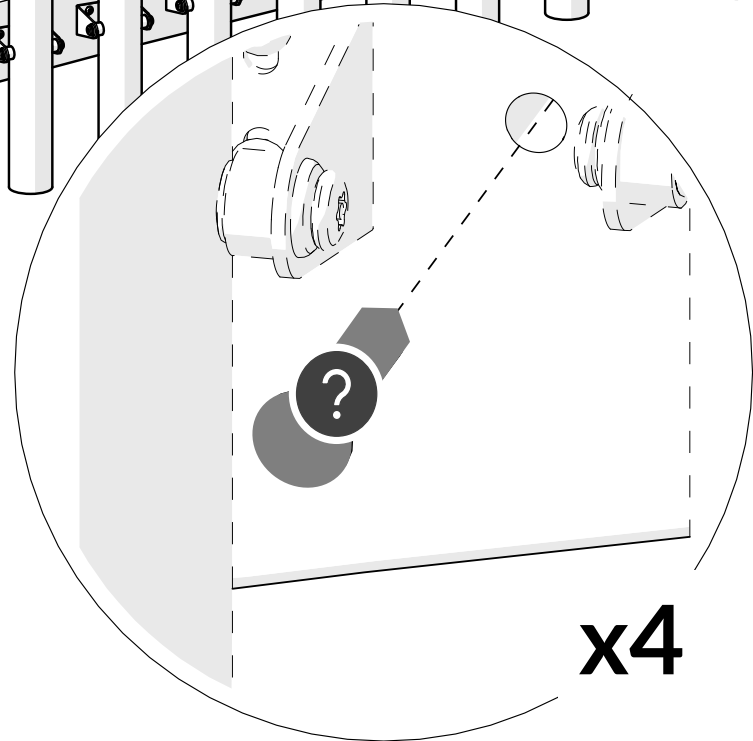

3.

cm inch

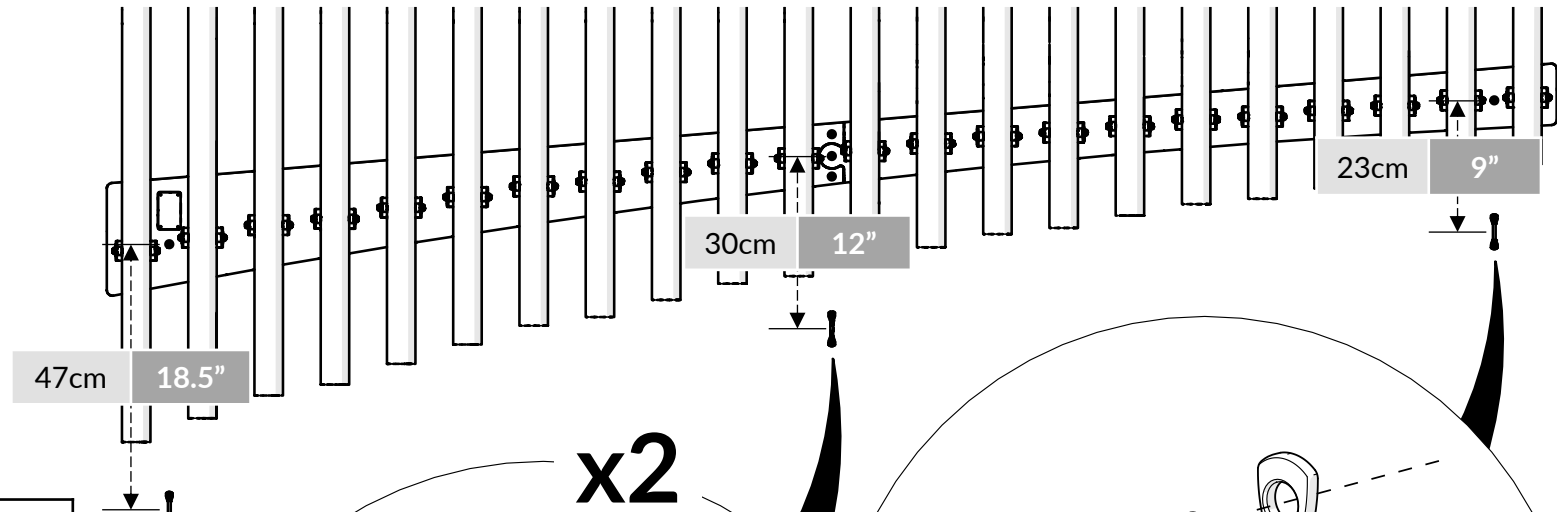

3		x2
4		x4
A		x3
B		x6

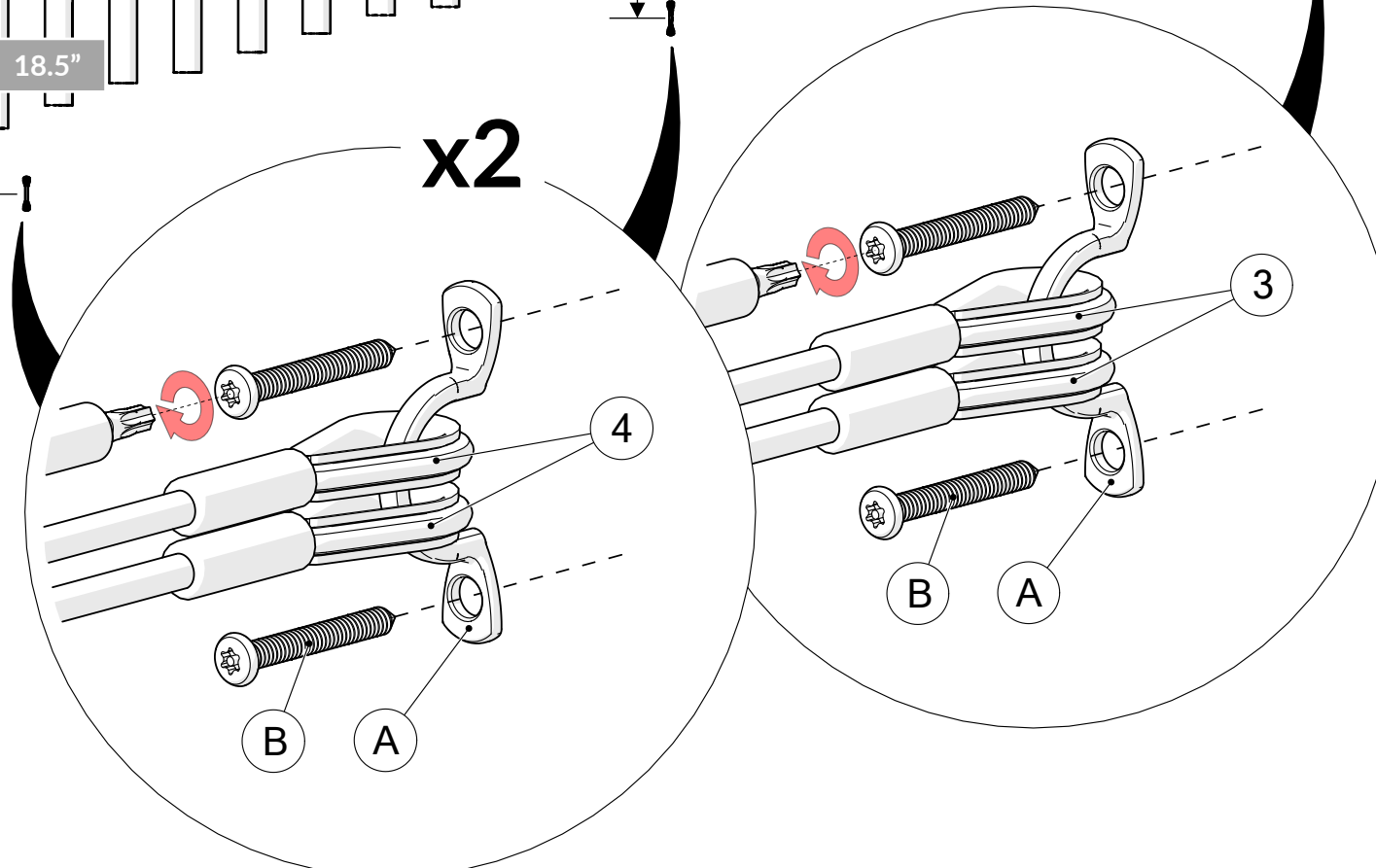

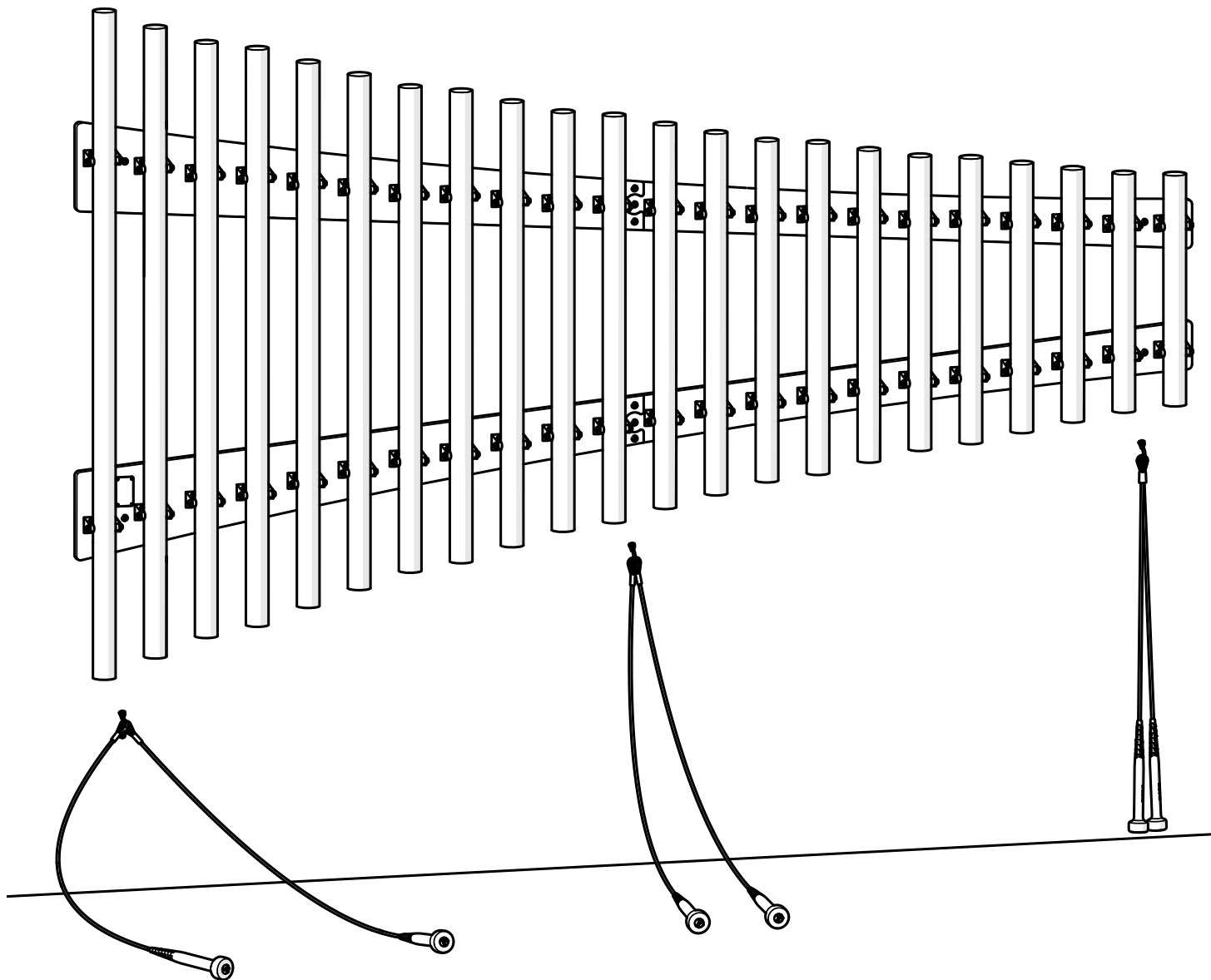

percussionplay.com



info@percussionplay.com



UK
[01730 235 180](tel:+441730235180)

USA & CAN
[+1 \(866\) 882 9170](tel:+18668829170)

EUR & ROW
[+44 1730 235 180](tel:+441730235180)